

ACCESSORIES CATALOG

for SEWING MACHINES

JANOME

ADDING TO YOUR SEWING ENJOYMENT



Janome accessories help make your sewing more comfortable and enjoyable. Each of our accessories has been developed to be easy to use and give beautiful results so that you can sew with confidence knowing it is a Janome. The first step in cultivating your sewing skills is choosing the right tools. Let this catalog guide you for the projects you may have in mind and serve as inspiration for your new ideas.

TABLE of CONTENTS

INTRODUCTION	2
JANOME QUALITY	7
CATALOG OF ACCESSORIES	13
■ for GENERAL SEWING MACHINES	14
■ for OVERLOCKERS	37
■ for COVER STITCH MACHINES	41
■ for PROFESSIONAL OVERLOCKERS and COVER STITCH MACHINES	46
■ for HIGH SPEED MACHINES	49
MISC. ACCESSORIES	56
■ NEEDLES	57
■ OTHER ACCESSORIES	62
INDEX	78

* Some accessories/products only available in certain markets.

INTRODUCTION

| Key Information of JANOME sewing machine

01

Maximum Zigzag Width

The maximum zigzag width of stitches is from 5 mm to 9 mm depending on the sewing machine.

High Shank and Low Shank of Presser Foot Holder

02

High shank means that the presser foot holder is installed at a higher position. Most sewing machines with embroidery features and/or the AcuFeed system are equipped with the high shank type of presser foot holder. Low shank means that the presser foot holder is installed at a lower position.

03

AcuFeed System

AcuFeed Flex is a feature only available on premium Janome sewing models. The system uses Upper Feed Teeth in conjunction with Lower Feed Teeth to gently move multiple layers of fabric through the machine. The Upper Feed Teeth move with the fabric as the Lower feed teeth move, feeding both the top and bottom layers of fabric at the same time. There are three variations of Acufeed Flex feet available in the Janome range: Twin, Single and Professional.

JANOME sewing machine Compatibility Quick Reference Guide

Use this quick reference guide to determine compatibility of an accessory with your Janome sewing machine.

A



Embroidery & Sewing models
(7 mm width)

B



Embroidery only models

C



Computer models
with AcuFeed system
(7 mm width)

D



Computer models
(7 mm/5 mm width)

E



Top-loading
(Horizontal Rotary Hook) models
(6.5 mm width)

F



Top-loading
(Horizontal Rotary Hook) models
(5 mm width)

G



Front loading
(Oscillating hook)
models

H



Overlockers
*excl models 203,888

I

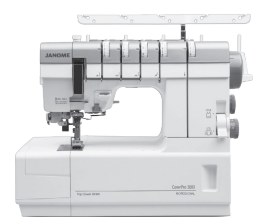

CoverPro models

J



High speed straight stitch models

K



Needle punching model

L

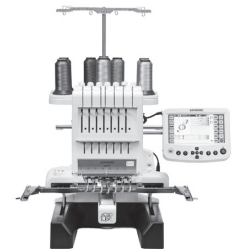

Multi-needle models

M



Combined overlock and
cover stitch models

N



Embroidery & Sewing models
with AcuFeed (9 mm)

O



Embroidery & Sewing models
(9 mm width)

P



Computer models with AcuFeed
(9 mm width)

Q



Computer models
(9 mm width)

For further information,
please refer to
the page 4 to 5.

JANOME sewing machine Compatibility Chart

Category	Features	Max. zigzag width	Shank	AcuFeed system	Model Name							
A	Embroidery & Sewing models (7 mm width) and SKYLINE S3	7 mm	High	No	SKYLINE S3	MC1000	MC5700 MC5000	MC8000	MC9000	MC9500	MC9700	MC10000/10001
					863	819	834	830	832	853	857	850
B	Embroidery only models				MC100E	MC200E	MC350E/300E	MC550E 500E 450E/400E				
					815	856	852	864				
C	Computer models with AcuFeed system (7 mm width) and MC6500P	7 mm	High	Yes	HMC7700QCP	MC6600P	MC6500P					
					858	846F	846A					
D	Computer models (7 mm/5 mm width)	7 mm	Low	No	MC5200	MC4900QC	MC4800	MC3500/3000	DC4030	3160QDC 2160DC/2030DC	SEWLA 5300QDC 5270QDC 5120QDC DC7100/DC6030	DC4100
					844	847	841	840	807	808	809	842
E	Top-loading (Horizontal Rotary Hook) models (6.5 mm width)	6.5 mm	Low	No	6019QC/6125QC	EasyJeans 22 MyStyle 22	HD2200 MyExcel 18/23	Décor 5124/5024/5018	MyExcel4014 4018/4023/4123	MS5027/MS5021 CS5031/SC5021		
					503	654	753	757	751	505		
F	Top-loading (Horizontal Rotary Hook) models (5 mm width)	5 mm	Low	No	Sewist 625E 525S/521 725S/721	FD216/212/206 Sew Mini Platinum	Jem Gold2	Jem Gold	Harmony 4045/4052			
					507	508	661	660	502			
G	Front loading (Oscillating hook) models	5 mm	Low	No	L-392/372	L-393/373	423S/415/405	JR1012	3012/3016/3022	311	1580LX	920
					731	721	303	743	306	311	748	304
H	Overlockers				990 90th Anniversary	8002D	9102D	ML213	ML454D Sailing Line	ML644D	ML554D Sailing Line	ML634D/1110DX DreamLock 70D EzyLock604D
					789	792	793	790	779	791	791A2	788
I	CoverPro models				900CP	1000CPX 2000CPX	CP3000P					
					795	796	778					
J	High speed straight stitch models				1600P	HD9P						
					767C	767F						
K	Needle punching model				FM725							
					725							
L	Multi-needle models				MB-4	MB-4S	MB-7					
					770	770	771					
M	Combined overlock and cover stitch models				1200D	1100D						
					797A	797C						
N	Embroidery & Sewing models with AcuFeed (9 mm)	9 mm	High	Yes	HMC15000	HMC14000	HMC12000	SKYLINE S9	CM17			
					862A	862F	859A	862SA	868A			
O	Embroidery & Sewing models (9 mm width)	9 mm	High	No	MC9900 MC9850							
					861							
P	Computer models with AcuFeed (9 mm width)	9 mm	High	Yes	SKYLINE S7	SKYLINE S6	HMC9450QCP HMC9400QCP	HMC8900QCP	HMC8200QC	MC6700P	CM7P	HMC9480QCP HMC9410QC
					863	863	865	858F	858G	866	867	869A/AL
Q	Computer models (9 mm width)	9 mm	High	No	SKYLINE S5	MC6650						
					863	866						

	Features	Max. zigzag width	Shank	AcuFeed system	Model Name							
A	Embroidery & Sewing models (7 mm width) and SKYLINE S3	7 mm	High	No	MC11000							
					860							
B	Embroidery only models											
C	Computer models with AcuFeed system (7 mm width) and MC6500P	7 mm	High	Yes								
D	Computer models (7 mm/5 mm width)	7 mm	Low	No	DC3018 DC3030 DC3060 DC8350/8330	6260QC	Jem Platinum	TS100Q TS200Q	M50QDC M100QDC M200QDC	S-750	M30A	Sewist 780DC 740DC
					843	845	806	811	812	749	805	814
E	Top-loading (Horizontal Rotary Hook) models (6.5 mm width)	6.5 mm	Low	No								
F	Top-loading (Horizontal Rotary Hook) models (5 mm width)	5 mm	Low	No								
G	Front loading (Oscillating hook) models	5 mm	Low	No	RX18S	Harmony 2039/2049	Jem Harmony 1017	726 670	729/72922S LR1122DX	523 3022	1522	
					722B	302	639	726	729	312	315	
H	Overlockers				ML654D Sailing Line	ML744D	AT2000DP					
					788A2	794	799					
I	CoverPro models											
J	High speed straight stitch models											
K	Needle punching model											
L	Multi-needle models											
M	Combined overlock and cover stitch models											
N	Embroidery & Sewing models with Acufeed (9 mm)	9 mm	High	Yes								
O	Embroidery & Sewing models (9 mm width)	9 mm	High	No								
P	Computer models with Acufeed (9 mm width)	9 mm	High	Yes	CM8P CM6							
					867C/CL							
Q	Computer models (9 mm width)	9 mm	High	No								

JANOME Accessory Catalog Usage Guide

The following information is available for each accessory.

① Name
② Photo
③ Description

① 1/4 INCH SEAM FOOT
②
③



WITH GUIDE
Achieve a perfect 1/4" (6.5mm) seam allowance along the edge of the foot. Great tool for quilt piecing and topstitching.

WITHOUT GUIDE
Recommended for areas where the guides get caught, such as where the stitching allowance overlaps.

<https://youtu.be/LZPElaLkAHc> 

200-318-000	A CDEF		BP
202-330-008	G	WITH GUIDE	BP
859-814-012	NO PQ		NP
202-529-002	A CDEF		BP
202-313-001	NO PQ	WITHOUT GUIDE	BP

④
⑤
⑥
⑦

Example (1/4 INCH SEAM FOOT)

- ④ Part Number
- ⑤ Compatible Model Category
(Refer to the page 4 to 5.)
- ⑥ Remarks
- ⑦ Package Specifications
-- 3 methods are available : BP, CB or NP

BP: Blister pack



CB: Cardboard box



NP: No packaging or shipped in a plastic bag



* Instructional video is available if there is a QR code that links to our official YouTube channel.

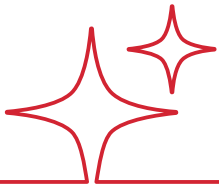

JANOME QUALITY

Janome Engineering and Craftsmanship for Better Quality Sewing

Exclusive features of Janome presser feet and accessories give you more control and accuracy for a higher quality finish. Calculated for effectiveness and full of originality, you can be assured that the history and tradition of quality Janome engineering is behind not only every sewing machine, but every presser foot and accessory as well.

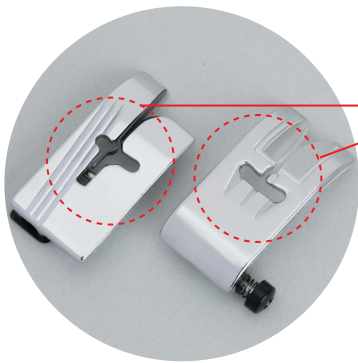

Grooves guide fabric and thread

Special grooves on the underside of feet promote optimal fabric feed for best results. On the left, the diagonal grooves on the underside of the blind hem foot improve contact of the fabric with the center guide plate for more accurate blind hems. On the right, outlets are provided on the underside of the zigzag foot to help grab the thread as it exits and improve stitch quality.

Button locks foot tilt

Who hasn't been frustrated by stitching bunching up before a thick seam? Although sewists normally appreciate the free tilt of a sewing foot, sometimes this feature can work against you when the foot comes up against a thick seam. To help you have perfect stitching over even the thickest seams, Janome provides a button on the zigzag foot that locks it horizontally parallel to the thread plate for smooth sewing over seams or other areas of significantly varying thicknesses. This feature can also be used at the beginning of sewing thick fabrics for a perfect start.

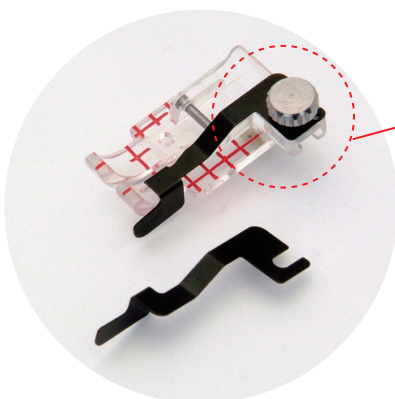
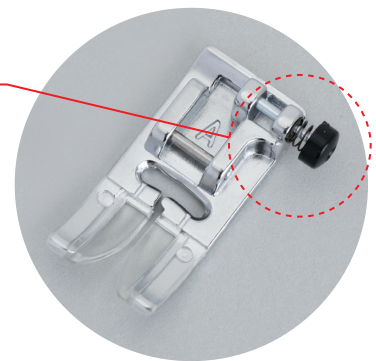

Multiple functions in one presser foot set

From idea to reality. When our customers say, "Wouldn't it be handy if...", we listen to their ideas. The feet that come with the convertible FMQ set are interchangeable and the guide on the 1/4 inch clear-view quilting foot can be removed. This means the feet can be matched precisely to the purpose with 1 set providing a range of functions. That's why these items fulfill user needs and are proving to be popular.



ACUFEED: Layered Fabric Feeding System

Janome truly integrates a built-in walking foot with a unique seven point feed dog system. Since the top layer is fed in perfect timing with the bottom layer, all fabrics move smoothly, even the slippery ones like velvet or thick layers of quilting fabric and batting, and heavy home dec yardage. Perfect feeding also means perfect alignment of patterns such as checks and plaids.

ACUFEED FLEX™

In addition to the original twin type, single type feet can now be used, expanding sewing possibilities. AcuFeed Flex™ keeps your thickest, trickiest layers moving in perfect sync with the feed dogs. You're going to love the new AcuFeed Flex™ feet for stitching your fluffiest quilts, installing zippers, or matching seams!

The AcuFeed Flex™ fabric feeding system is fully detachable and easy to remove when you're not using it. Select the presser foot that best matches your sewing needs and attach. Simply snap off when not in use and store out-of-the-way in one of the ample accessory trays. Multiple twin type and single type feet are available to address different tasks.



*The product named "AcuFeed" in this catalog is identical to the product named "Dual feed" in the sewing machine instruction manual.



AcuFeed (twin type):

The twin type AcuFeed attachments give you superior stability by taking full advantage of a wider stance. Engage the exclusive AcuFeed fabric feeding system and feel your project moving together under the needle with perfect precision.

ACUFEED 1/4 INCH SEAM FOOT AND NEEDLE PLATE
(Dual feed 1/4 inch seam foot and needle plate)

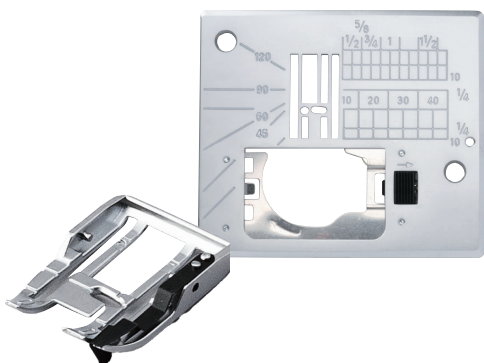

Guides edge of fabric to help you sew perfect 1/4 inch seams, especially useful for patchworking. The small needle hole on the needle plate prevents fabric from being pushed under the needle plate.

846-407-007	C*	ACUFEED 1/4 INCH SEAM FOOT AND NEEDLE PLATE(Dual feed 1/4 inch seam foot and needle plate)	BP
-------------	----	--	----

* Needle plate only compatible with MC6600P

202-031-002	C	ACUFEED 1/4 INCH SEAM FOOT (Dual feed 1/4 inch seam foot)	BP
202-125-004	N P	ACUFEED QUILT PIECING FOOT (Dual feed quilt piecing foot)	BP

ACUFEED OPEN TOE FOOT (Dual feed open toe foot)

Front of foot has been removed for clearer visibility when sewing. Great for applique, monogramming, cutwork and quilting.



846-410-003	C		BP
202-149-004	N P		BP

ACUFEED DITCH QUILTING FOOT (Dual feed ditch quilting foot)

Center-position guide follows a seam line precisely, allowing perfect in-the-ditch quilting. Used in conjunction with various needle positions, it is also perfect for topstitching or under-stitching a facing.



846-413-006	C		BP
202-103-006		N P	BP

ACUFEED STRAIGHT STITCH FOOT (Dual feed straight stitch foot)

The circle hole in the foot holds the thread in place and allows for a quality straight stitch. Using together with straight stitch needle plate is recommended.



202-102-005		N P	BP
-------------	--	-----	----



AcuFeed (single type):

The single type dual feed attachments let you get in close to sew a narrower area as well as the edges of cloth.

ACUFEED FOOT WITH FOOT HOLDER (Dual feed plus foot with foot holder)

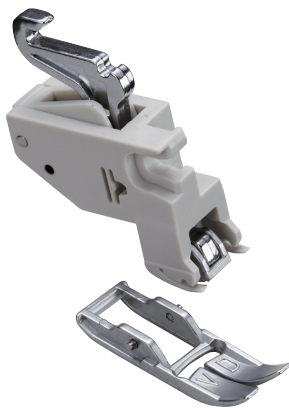

This foot has the power to feed fabrics. It is especially effective for top-stitching on the edge of the fabric and stitching on narrow strips.

202-127-006	N P	BP
-------------	-----	----

ACUFEED ZIPPER FOOT (Dual feed plus zipper foot)

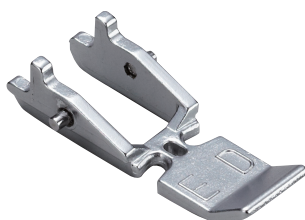

Zippers can be attached to plastic coated fabric, leather and any tricky to handle materials without any difficulty.

202-128-007	N P	BP
-------------	-----	----

ACUFEED FLEX PROFESSIONAL GRADE FOOT (Dual feed plus professional grade foot)

This foot provides superior visibility and is great for curves and precise topstitching. It holds fabrics firmly in sync with the feed dogs to achieve professional results.

* To use this accessory, you will need the HP needle plate that comes with your sewing machine.



202-415-004	N*1 P*2	BP
-------------	---------	----

*1 For use with HMC15000, SKYLINE S9 Ver. 2.00 or later, CM17 only
 *2 For use with SKYLINE S7 Anniversary Edition, HMC9480QCP, HMC9410QC, HMC9450QCP, HMC9400QCP, CM8P, CM7P, CM6 only

A.S.R.[®]



The Accurate Stitch Regulator reacts to the movement of the fabric and provides the same stitch length for Free Motion, Ruler Work, or Echo quilting. The A.S.R. is like training wheels for your Free Motion Quilting. This device uses an optical sensor to ensure that your stitches are the same length as you are Free Motion Quilting. The sensor reads how fast you are moving the quilt under the needle so that it can adjust the stitches to remain the same length.

Contents

- A.S.R. (Accurate Stitch Regulator) with ASR-QC
- A.S.R. open-toe foot ASR-QO
- A.S.R. clear-view foot ASR-QV
- A.S.R. ruler work foot ASR-QR

869-411-005	N*1 P*2	CB
-------------	---------	----

*1 For use with CM17
 *2 For use with CM8P, HMC9480QCP

A.S.R. (Accurate Stitch Regulator) with ASR-QC



A.S.R. open-toe foot ASR-QO



A.S.R. clear-view foot ASR-QV



A.S.R. ruler work foot ASR-QR



CATALOG OF ACCESSORIES

Using the correct presser foot and accessory for the job at hand not only makes it easier to complete, but also lets you achieve more beautiful finished results. Further it means that you will have less strain on your eyes for a more enjoyable sewing experience. Let this catalog guide you to the right accessories to meet your sewing needs.

Use the handy quick reference guide to determine the compatibility of each accessory with your Janome sewing machine.

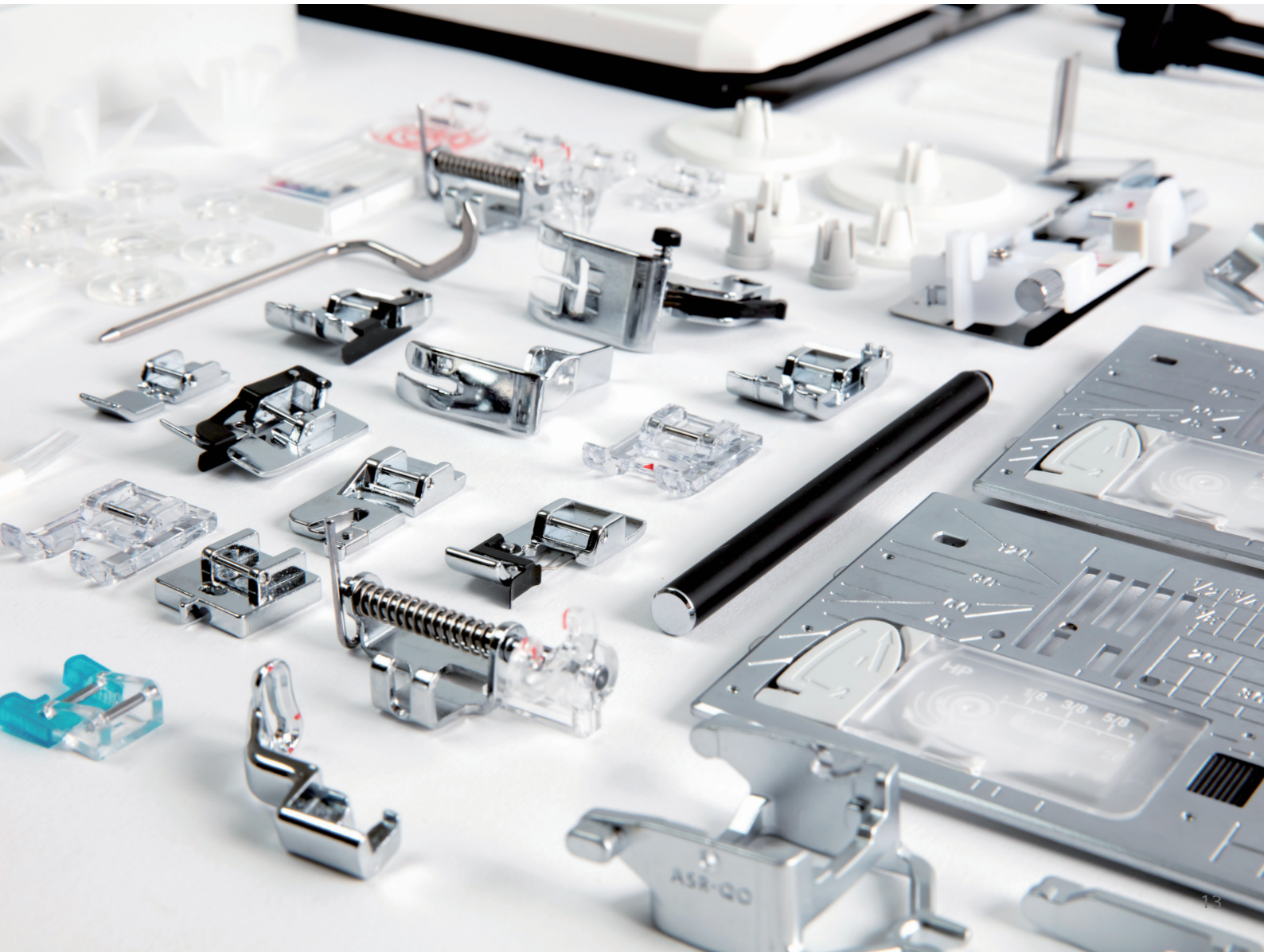

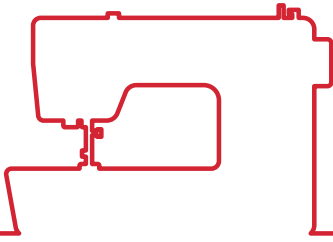

GENERAL SEWING MACHINE ACCESSORIES

General sewing machines are versatile and user friendly.
Let Janome presser feet and accessories expand your sewing repertoire.

STRAIGHT STITCH FOOT



The straight stitch foot is flat on the underside to provide even pressure against the feed dogs and it has a rounded needle hole which offers the benefit of more support around the needle to prevent skipped stitches and puckering.

<https://youtu.be/jYHUrYeTNSM>



200-331-009	A CDEF		BP
200-125-008	G		BP
202-083-009		NOPQ	BP

APPLIQUE FOOT



This presser foot is shorter than most for easier maneuvering around curves and corners when sewing applique pieces. Made of clear plastic for easier viewing as you sew.

<https://youtu.be/44-wyVT-2os>



202-023-001	A CDEF		BP
202-086-002		NOPQ	BP

SLIDING GUIDE FOOT

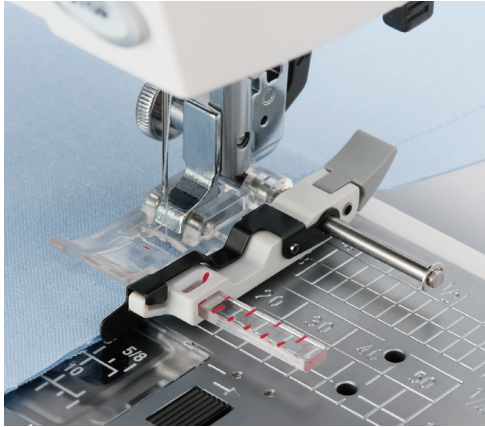

This foot is ideal for seaming with a 5/8 inch allowance, and the adjustable seam guide allows precise edge stitching and hemming.

<https://youtu.be/3t0oagQQ0Ik>



202-293-004	NOPQ		BP
202-218-005	A CDEF		BP

ROLLER FOOT



As its name suggests this foot has rollers that roll against the fabric and act very much like the track on a bulldozer for sewing up and over heavy seams and uneven surfaces. Ideal for sewing heavy fabrics, the rollers move freely between the foot and the feed dogs so that the foot rides easily over varying thicknesses. Also used to sew sticky leathers and vinyl.

200-316-008	A CDEF		BP
200-142-001	G		BP

DARNING FOOT



Sometimes referred to as the embroidery foot, the darning foot is used for 'free hand' embroidery and darning to ensure proper stitch formation, minimize skipped stitches and puckering and also protect your fingers while you move the fabric freely under the needle. Especially beneficial to those just learning how to do free hand embroidery. The open toe version greatly improves visibility of stitches and is especially popular with quilters.

200-325-000	A C	REGULAR	BP
200-349-000	DEF		BP
200-127-000	G		BP
859-839-002	NOPQ		NP
200-337-005	A C	OPEN TOE	BP
200-340-001	DEF		BP
202-314-002	NOPQ		BP

ULTRA GLIDE NEEDLE PLATE & ULTRA GLIDE FOOT



Molded from a special resin that allows easier sewing of sticky materials, the ultra glide foot moves smoothly over faux leather, ultra suede, vinyl and even plastics on the ultra glide needle plate. This non-stick attachment glides along with no drag so you can sew on these surfaces just like they were regular fabric.



<https://youtu.be/xXUQ9v3dLSc>

200-329-004	A CDEF		BP
200-141-000	G	ULTRA GLIDE FOOT	BP
202-091-000	NOPQ		BP
202-201-005	N*1OP*2Q	ULTRA GLIDE NEEDLE PLATE & ULTRA GLIDE FOOT	BP
202-431-006	N*3 p*4		BP

*1 excl. CM17 *2 excl. CM8P, CM7P, CM6
 *3 For use with CM17 only *4 For use with CM8P, CM7P, CM6 only

HD ROLLER FOOT



An innovative new foot that can smoothly control materials such as leather and vinyl which are prone to catch. When using this foot, the base of the needle is clearly visible, making your work easier.

202-418-007	A C	J NOPQ		BP
-------------	-----	--------	--	----

SATIN STITCH FOOT



For sewing dense zigzag stitching. The bottom of the foot is beveled for smooth delivery of thread when sewing decorative or satin stitches. Foot is made of clear plastic making it easier to view stitching.

822-804-129	A CDEF		NP
200-129-002	G*1		NP
859-806-011	NOPQ		NP

*1 Foot is made of metal.

GATHRING FOOT



This foot is for creating soft gathers in lightweight fabrics. The underside of the foot is raised behind the needle and has a thick bar in front of the needle to gather and attach a ruffle onto a flat piece of fabric simultaneously. Use a ruffler to obtain a more dramatic gather.

<https://youtu.be/M7rvzWc8eg8>



200-315-007	A CDEF		BP
200-124-007	G		BP
202-096-005	NOPQ		BP

CUSTOM CRAFTED ZIGZAG FOOT



The open toe on this foot allows a better view of the sewing in progress. This foot can be used for quilting, monogramming, applique, and cut work.

* The product named "Custom crafted zigzag foot" in this catalog is identical to the product named "Open toe satin stitch foot" in the sewing machine instruction manual.

<https://youtu.be/CDJNQ8xfVbE>



200-137-003	A CDEF		BP
859-813-000	NOPQ		NP

BINDER FOOT



The binder foot is used to apply pre-folded bias binding tape or bias tape you have cut yourself to the edge of fabric in one easy step. It is equipped with a small funnel to fold and guide the binding over the fabric edge before it reaches the needle and can be used with either zigzag or decorative stitches as well as straight stitch. 10 mm to 14 mm bias tape can be used.

200-313-005	A CDEF		BP
200-140-009	G		BP
202-099-008	NOPQ		BP

BI-LEVEL FOOT

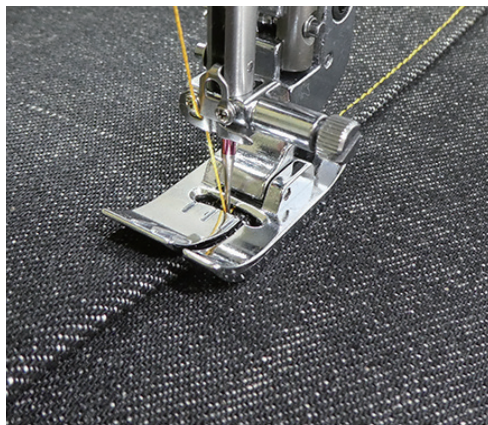

This foot enables sewing at a constant width from the fold of the fabric. It guides your top stitching and edge stitching perfectly. Thick materials (e.g. wool, denim, tweed) can be finished.

<https://youtu.be/zJmLEfwtc3w>



202-504-001	A CD*1	RIGHT BI-LEVEL FOOT	BP
202-461-005	NOPQ		BP
202-538-004	A CD*1	LEFT BI-LEVEL FOOT	BP
202-522-005	NOPQ		BP

*1 excl. Jem Platinum, S-750 and M30A

TAPING GUIDE FOOT



Use this foot for attaching tape to the edge of fabrics. Adjust the needle drop position with the thumb screw. Guide the fabric with the left hand and tape with the right hand.

202-310-008	NOPQ		BP
202-311-009	A CDEF		BP

LAP-SEAM FOOT

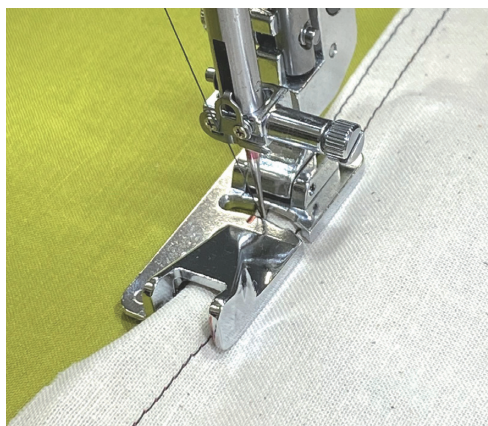

This foot can provide perfect looking and durable seams on medium-heavy weight to heavy weight fabrics. You can create beautiful lap-seams without ironing.

<https://youtu.be/kNbYuLv8fyU>



202-503-000	A CDEF		BP
202-463-007	NOPQ		BP

OVERCASTING FOOT / OVEREDGE FOOT

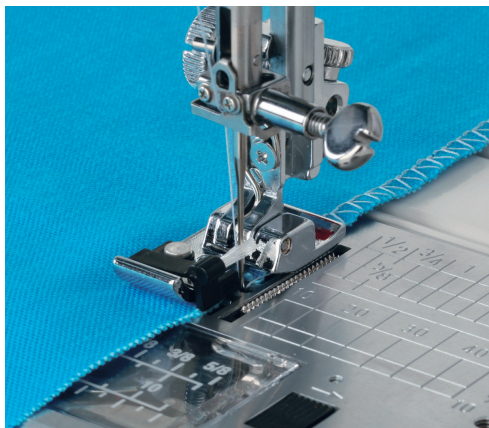

The Overedge Foot and Overcasting Foot help finish fabric edges and prevent fraying. They guide the fabric and create neat stitches.

822-801-001	A CDEF	OVEREDGE FOOT	NP
200-132-008	G		BP
822-808-008	A CD* ¹	OVERCASTING FOOT	NP
859-810-007	NOPQ		NP

*1 excl. MC3500, MC3000, 6260QC

BLIND HEM FOOT



Blind hemming can sometimes be a little bit tricky so the blind hem foot goes some way to helping improve this technique. The foot has a metal guide in the center and three grooves on the underside. During blind hemming, the fold of the fabric fits snugly against the guide in the foot for accuracy while the grooves underneath help to prevent unnecessary slipping. The needle swings over the metal guide creating slack in the upper tension so that the pick of the stitch is almost invisible.

<https://youtu.be/H7yWpMmlVck>



825-817-009	A CDEF		NP
820-817-015	A CDEF* ¹		NP
200-130-006	G		BP
859-807-001	NOPQ		NP

*1 Foot is equipped with a screw.

TRICOT FOOT



This foot prevents puckering and fabric slippage on stretch fabrics.

202-509-006	G		BP
-------------	---	--	----

ZIPPER FOOT



This foot can be set to sew on each side of the zipper. The edge of the foot guides the zipper to ensure straight placement.

808-852-003	A CDEF	(SNAP ON)	NP
940-290-000	G		NP
859-805-009	NOPQ		NP
200-334-002	A C	(SCREW ON)	BP
200-342-003	DEFG		BP

CONCEAL® ZIPPER FOOT



Good quality ready to wear garments will often have an invisible zip fitted. These zippers are often neglected by the home dressmaker which is a pity because they can ensure success every time. Invisible zips are suitable for all fabrics from fine silk jersey through to suit weight wools and tweeds. The key is to get the needle as close to the fastener as possible, which this foot accomplishes by slightly unrolling the zipper just before the needle. Once fitted, a well sewn invisible zipper will merely look like part of the seam.

200-333-001	A CDEF	(SNAP ON)	BP
202-475-002	G		BP
202-144-009	NOPQ		BP
941-800-000	G	(SCREW ON)	NP

CONCEAL is a registered trademark of YKK Corporation.

HEMMER FOOT



The hemmer foot, sometimes referred to as the rolled hemmer, is used to stitch the narrow rolled hems usually found on shirt tails, table linens and along the edge of frills. The hemmer is designed with a scroll shaped feeder on top and a straight groove on the underside which determines the width of the finished hem. The 4 mm/6 mm set will allow for the use of heavier fabrics.

<https://youtu.be/rxlqrGWeL6g>



200-326-001	A CDEF	HEMMER FEET SET (4 mm & 6 mm hems)	BP
202-081-007	NOPQ	ROLLED HEM FOOT (4 mm)	BP
202-080-006	NOPQ	ROLLED HEM FOOT (6 mm)	BP
820-809-014	A CDEF	ROLLED HEM FOOT	NP
202-044-008	G		NP
859-804-008	NOPQ		NP
202-477-004	G	ROUND HEM FOOT	BP

ROTARY EVEN FOOT

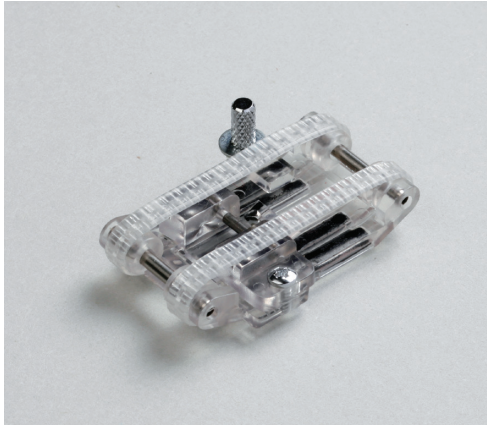

For use with all sewing machines, the rotary foot is effective for preventing stretchy fabrics, jersey and knitted fabrics and hard to feed materials like leather or vinyl, from slipping or puckering. The foot also allows left-right tilt and its caterpillars independently grip the fabric for perfect feeding along areas where there is a height difference between the left and right sides of the needle especially when hemming thicker fabrics.

* When using zigzag stitch, set the stitch width at a setting less than 5mm.

CAUTION: In order to avoid needle breakage, do not set stitch width at more than 5mm.

323-77-77

A CDEF

CB

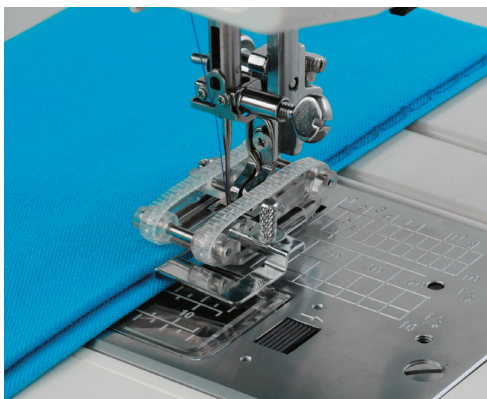

BLIND HEM ATTACHMENT

The blind hem attachment enables accurate feeding of the fabric to achieve a consistent blind hem.



BIAS TAPE ATTACHMENT

The bias tape sewing attachment is adjustable and enables you to attach folded bias tape up to 20 mm wide.



WIDE ROLLED HEM ATTACHMENTS

The wide rolled hem attachments enable wide rolled hems to be sewn in the following sizes: 1/2 inch, 3/4 inch, and 1 inch.

PIPING FOOT



If ready made piping cord is not available or if you just want to make your own, the piping foot is ideal for the job. The piping foot is designed with two grooves on the underside and will hold and cover the cord when making piping tape. It can also be used for attaching piping. Maximum cord size is 5 mm.

200-314-006	A CDEF		BP
202-088-004		NOPQ	BP

PIPING FOOT (NARROW)

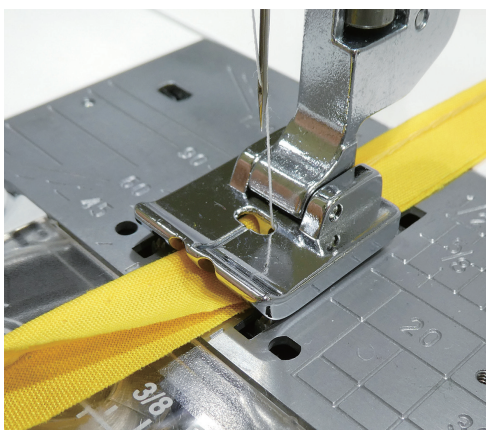

This foot is used for piping with a cord diameter of about 2 mm. It is useful for making narrow piping tape using the same fabric as the piece of work, or for attaching piping tape to fabric.

202-502-009	A CDEF		BP
202-462-006		NOPQ	BP

RUFFLER



Rufflers have been around for a very long time and have changed very little over the years; they have however remained very popular. Although at first sight a ruffler may appear bulky and complicated, its innovative design actually makes it very easy to use. This design allows fabric to be ruffled or pleated to the desired fullness quickly and easily and also has the capability to vary the sizes of ruffles.

943-100-000	A DEFG		CB
846-415-008	A CDEFG		BP
202-095-004		NOPQ	BP

PINTUCKING FEET

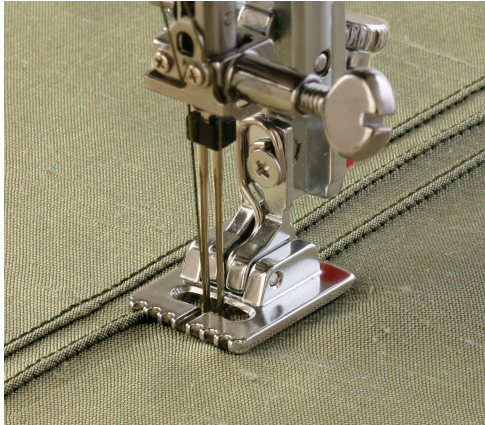

The pintucking foot is used with a 2 mm twin needle to create multiple rows of pintucks. The grooves on the underside of the foot make it easy to stitch several rows parallel and evenly spaced from each other.

200-317-009	A CDEF	SET OF TWO FEET (narrow grooved and wide grooved)	BP
200-328-003	G	SINGLE FOOT (narrow grooved only)	BP
202-094-003	NOPQ	PINTUCKING FOOT (narrow)	BP
202-093-002	NOPQ	PINTUCKING FOOT (wide)	BP

PINTUCKING CORD GUIDE



The cord guide is attached in place of the clear plastic bobbin cover to feed perle cotton or other cord as you sew for easier corded pintucks. Two guides are included in the set: one for cord up to 1.5 mm in diameter and one for cord 1.5 - 2.5 mm in diameter.

Part Number	Package	Remarks	Compatible Models						
			Harmony 4045/4052	6019QC 6125QC	FD216/212/206 Sew Mini Platinum	M30A	3160QDC 2160DC 2030DC	4120QDC 5120QDC 4300QDC	TS100Q TS200Q
503-813-008	CB	Easy Set Bobbin System is not supported	502	503	508	805	808A/D/F/S/X	809A/AS	811A
			6260QC	MC6600P MC6500P	HMC8900QCP HMC8200QC	HMC12000	MC11000		
			845	846A/F	858F/G	859A	860		
200-324-009	BP	Easy Set Bobbin System is not supported	MS5027 MS5021 CS5031 SC5021	Sewist 625E 525S/521 725S/721	Easy Jeans 22 MyStyle 22	Jem Gold	Jem Gold2	MyExcel 4014/4018 4023/4123	HD2200 MyExcel 18/23
			505	507	654	660	661	751	753
			Décor 5124 5024 5018	Jem Platinum	DC4030	MC8000	MC9000	MC5700 MC5000	MC3500 MC3000
			757	806	807	830	832	834	840
			MC4800	DC4100	DC3018 DC3030 DC3060 DC8350	MC5200	MC4900	MC10000 MC10001	MC9500
			841	842	843	844	847	850	853
			MC9700						
857									
202-213-000	BP	Metal Needle Plate with Easy Set Bobbin System is required	5300QDC 5270QDC SEWLA	M50QDC M100QDC M200QDC	Sewist 780DC 740DC	MC1000	HMC8900QCP SE	HMC8200QCP SE	MC9900 MC9850
			809AU/AU2/F	812	814	819	858F2	858G2	861
			HMC14000 HMC15000 SKYLINE S9	SKYLINE S3/S5/S6/S7	HMC9450QCP HMC9400QCP	MC6700P MC6650	HMC9480QCP HMC9410QC	CM8P CM7P CM6	CM17
			862A2/A3/S	863	865	866	869	867	868

BEADING FOOT



Sewing on strung beads and pearls has always been a tedious task but the beading foot now goes some small way to alleviating this and to add pleasure to embellishing. Popular for bridal wear, evening wear, smart/casual or crafts, the beading foot set is a blessing. There are two feet in the set: narrow groove for beads up to 2 mm in diameter and wide groove for beads 2.5 - 4 mm in diameter.



<https://youtu.be/3cbClxzXTbo>

200-321-006	A CDEF	SET OF TWO FEET(narrow and wide)	BP
202-097-006	NOPQ	BEADING FOOT(narrow)	BP
202-098-007	NOPQ	BEADING FOOT (wide)	BP

3-WAY CORDING FOOT



The 3-way cording foot will hold one, two or three fine cords or threads. Because they are attached to the foot, the required design can be easily followed and the cords are perfectly placed. A variety of utility or decorative stitches can be sewn over the cords to couch them onto base fabrics. The choice of cord, thread and stitch are all contributory factors to the final effect.

200-345-006	A CDEF		BP
200-126-009	G		BP
202-085-001	NOPQ		BP

9-HOLE CORDING FOOT

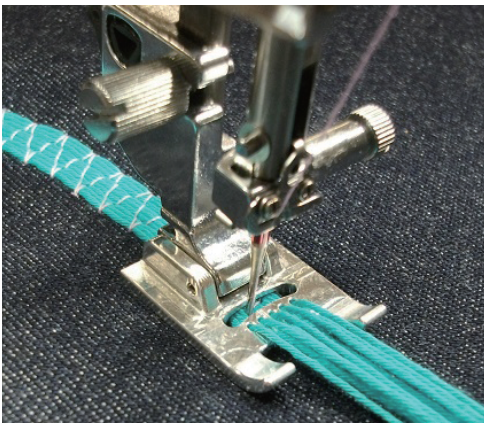

This foot enables you to attach up to 9 cords together by threading the cords through the 9 holes on the foot. Use soft cords (Diameter approximately 1 mm).

202-506-003	NOPQ		BP
-------------	------	--	----

RIBBON/SEQUIN FOOT

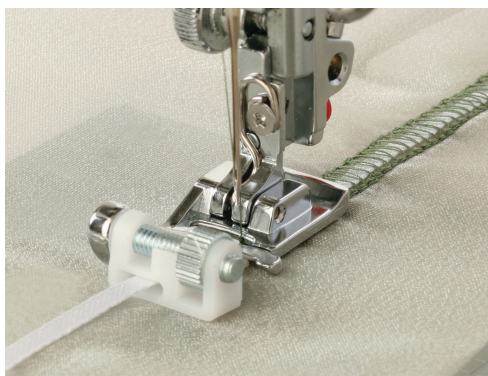

As with beads and pearls it is now so much easier to attach ribbons and even sequins with the help of our special ribbon/sequin foot. This foot is designed with guides through which ribbon or strung sequins can be inserted and it will allow them to feed through evenly as you sew. Besides affixing the ribbon, a wide ladder stitch can be used with narrow ribbon to make an easy and functional drawstring.

https://youtu.be/zCwtSaC_Wbs



200-332-000	A CDEF		BP
202-090-009		NOPQ	BP

TRANSPARENT BUTTONHOLE FOOT

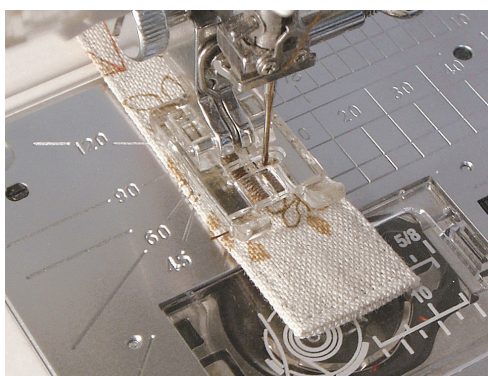

For sewing buttonholes on tight areas such as cuffs and other areas where more freedom of movement is required than available with a sliding-type buttonhole foot.

<https://youtu.be/53WA6FcVfcc>



820-801-016	A CDEF		NP
202-082-008		NOPQ	BP

SLIDING BUTTONHOLE FOOT



For easy 4-step buttonholes on front loading machines. (Sliding buttonhole foot included as standard accessory on all sewing machines with a 1-step buttonhole function.)

200-123-006	G	REGULAR	NP
200-134-000	G	WITH BUTTON SIZER	BP

BUTTON SEWING FOOT



Quick and easy button sewing with the special button sewing foot. This foot has two bars that attach to the foot shank to provide extra stability and also has a textured, rubber sleeve to hold the button securely in place while sewing.

https://youtu.be/A6p6Sv9PH_8



200-136-002	A CDEF		BP
200-131-007	G		BP
859-811-008		NOPQ	NP

1/4 INCH SEAM FOOT



WITH GUIDE

Achieve a perfect 1/4" (6.5mm) seam allowance along the edge of the foot. Great tool for quilt piecing and topstitching.

WITHOUT GUIDE

Recommended for areas where the guides get caught, such as where the stitching allowance overlaps.

<https://youtu.be/L2PElaLkAHc>



200-318-000	A CDEF	WITH GUIDE	BP
200-330-008	G		BP
859-814-012	NOPQ		NP
202-529-002	A CDEF	WITHOUT GUIDE	BP
202-313-001	NOPQ		BP

CLEAR VIEW 1/4 INCH SEAM FOOT



This foot allows you to sew 1/4 inch seam piecing, indispensable for quilt work, using the straight stitch needle plate.

The small single hole in both the plate and the foot ensures the most control over fabric possible and the least risk of threads or fabric getting caught in the feed dogs.

*Must be used with a straight stitch in center needle drop position.

202-216-003	NOPQ		BP
-------------	------	--	----

DITCH QUILTING FOOT



A very useful addition to the sewing room when wanting a perfectly straight "stitch in the ditch". The guide on the foot spreads the seams allowing you to stitch perfectly in the ditch, and is also useful when adding decorative top stitching along seams.

<https://youtu.be/JYDu7xHIUEI>



200-341-002	A CDEF		BP
202-087-003	NOPQ		BP

CLEAR VIEW QUILTING FOOT AND GUIDE SET



An essential set for all quilters because it covers a range of quilting tasks through the attachment or removal of two fabric guides and the use of a clear view foot. Create accurate 1/4 inch seams with the 1/4 inch guide, or remove the guide to make a 1/8 inch seam for miniature piecing using the handy markings on the clear foot. To decorate your quilt, attach the center guide to ensure a neat “stitch in the ditch” for the perfect finishing touch.

Contents

- Clear view quilting foot
- 1/4 inch seam guide
- Ditch quilting guide

<https://youtu.be/yz6Z5QzbYr8>



200-449-001	A CDEF		BP
202-089-005		NOPQ	BP



Simply attach the 1/4 inch fabric guide which aligns with the edge of the material to produce an accurate 1/4 inch seam with ease. The oval hole in the clear view foot allows for needle adjustment of up to 1 mm to create a scant 1/4 inch seam.



Add dimension to your quilt using the “stitch in the ditch” technique. The center guide attached to the foot spreads the seams to create perfect stitching in the ditch. Don’t stop with straight ditch stitching - experiment with decorative stitches for eye-catching embellishment.

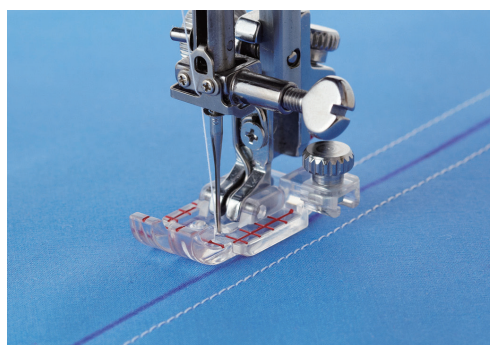

Some quilting techniques may require you to sew with some fabric under the fabric guide, so use the clear view foot without a guide to help the fabric move easily under the foot. The markings on the foot act as a guide for 1/4 inch and 1/8 inch seams.

EVEN FEED FOOT WITH QUILTING GUIDE

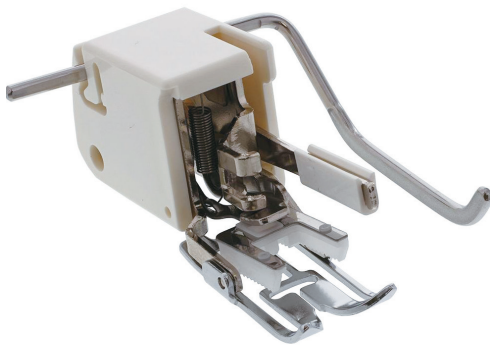

The even feed foot, sometimes referred to as the walking foot, is designed with a set of feed dogs (teeth) which allow the fabric to feed without shifting and eliminates the problems of the underlayer of fabric coming up short. The even feed foot is great for topstitching which can be spoilt due to irregularity of stitching. Also includes metal quilting guide.



<https://youtu.be/oEbfPismspk>

200-309-008	A		BP
200-311-003	DEF	REGULAR	BP
200-310-002	G		BP
200-338-006	A	OPEN TOE	BP
200-339-007	DEF		BP

CONVERTIBLE EVEN FEED FOOT SET

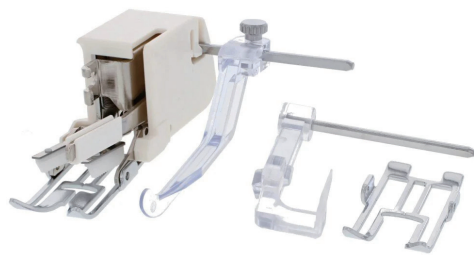

The set includes even foot unit, open toe foot, ditch quilting guide and adjustable quilting guide bar.



<https://youtu.be/XgUPgP9tE9E>

214-516-003	A		BP
214-517-004	DE		BP
202-133-005		O Q	BP

DITCH QUILTING GUIDE AND ADJUSTABLE QUILTING GUIDE SET



A separate quilting guide bar and ditch quilting guide bar set is available for those who already own the even feed foot.

214-518-005	For even feed foot		BP
-------------	--------------------	--	----

LONG QUILTING GUIDE BAR SET



This set includes two guides that can be attached to the left or right of the needle to create parallel rows of stitching approximately two times wider than rows made with the regular quilting guide. Just snap one of the guides into place at the back of the even feed foot and adjust the distance from the needle as required. The guides can also be inserted into a regular foot holder.

202-025-003	A CDEF	NOPQ		BP
-------------	--------	------	--	----

1/4 INCH RULER FOOT

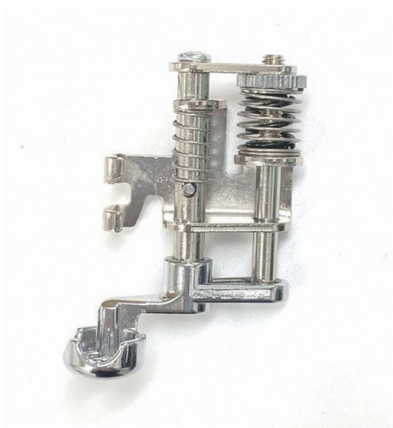

The 1/4 INCH RULER FOOT was specifically designed to use with quilting rulers for ruler work. The key point of the foot is the 1/4 INCH cup height which moves smoothly alongside the quilting ruler without allowing the ruler to slide over or under the foot. The needle drops a 1/4 INCH away from the ruler to create the quilting line.

202-442-000	DE			BP
202-441-009	A C	OPQ		BP

CONVERTIBLE FREE MOTION QUILTING FOOT SET



This set includes three feet that can be used with a variety of fabrics for free motion quilting projects. Select the most appropriate foot for the task and attach to the foot holder with a quick screw adjustment. The height of all feet can also be adjusted so they glide effortlessly over layers of fabric.

202-001-003	A C		BP
202-002-004	DE		BP
202-146-001*	NOPQ		BP

* Please refer to the table below.

CLOSED-TOE FOOT



Convenient for lace and other fabrics that catch on an open toe, this general use foot is also good for holding the fabric in front of the needle.

OPEN-TOE FOOT



Also for general use, but with greater visibility around the needle to assist formation of a precise design.

CLEAR VIEW FOOT



The clear view foot moves smoothly over uneven layers such as fabric with cording or ribbon, and can also be used with zigzag stitches.

Ordinary sewing

Foot		Closed-toe foot (L)	Open-toe foot (L)	Clear-view foot (L)	Clear-view foot (M)
859A	HORIZON MC12000	• Feed dog: Down • Needle position: Left	• Feed dog: Down • Needle position: Left	• Feed dog: Down • Needle position: Left	• Feed dog: Down
858F	HMC8900QCP				
858G	HMC8200QC				
861A	MC9900				
861AL	MC9850				
862A	HORIZON MC15000				
862A2					
862F	HORIZON MC14000				
863AU	SKYLINE S7				
863F	SKYLINE S6				
863A	SKYLINE S5				
862A3	HORIZON Quilt Maker MC15000	• Feed dog: Down • Needle position: Left	• Feed dog: Down • Needle position: Left	• Feed dog: Down • Needle position: 1.0 • ZigZag needle plate	• Feed dog: Down
862SA	SKYLINE S9				
865C	HMC9450QCP				
865A	HMC9400QCP				
866A	MC6700P				
866D	MC6650				
867A	CM7P				
867C	CM8P				
867CL	CM6				
869A	HMC9480QCP				
869AL	HMC9410QC				
868	CM17				

Sewing application

Foot/ Machine Setting		Closed-toe foot (L)						Open-toe foot (L)						Remarks
		Straight Stitch 1	Straight Stitch 2	Straight Stitch 3	Straight Stitch 4	ZigZag Stitch 1	ZigZag Stitch 2	Straight Stitch 1	Straight Stitch 2	Straight Stitch 3	Straight Stitch 4	ZigZag Stitch 1	ZigZag Stitch 2	
859A	HMC12000	No	No	-	-	No	No	No	No	-	-	No	No	
861A	MC9900	No	No	-	-	No	-	No	No	-	-	No	-	Zigzag stitch1: Zigzag
861AL	MC9850	No	No	-	-	No	-	No	No	-	-	No	-	
862A/A2/A3	HMC15000	No	No	-	-	No	No	No	No	-	-	No	No	
862F	HMC14000	No	No	-	-	No	No	No	No	-	-	No	No	
862SA	SKYLINE S9	No	No	-	-	No	No	No	No	-	-	No	No	
863AU	SKYLINE S7	No	No	-	-	No	No	No	No	-	-	No	No	
865C	HMC9450QCP	No	No	-	-	No	No	No	No	-	-	No	No	
865A	HMC9400QCP	No	No	-	-	No	No	No	No	-	-	No	No	
867A	CM7P	No	No	-	-	No	No	No	No	-	-	No	No	
867C	CM8P	No	Yes	No	No	No	No	No	Yes	No	No	No	No	
867CL	CM6	No	Yes	No	No	No	No	No	Yes	No	No	No	No	
869A	HMC9480QCP	No	Yes	No	No	No	No	No	Yes	No	No	No	No	
869AL	HMC9410QC	No	Yes	No	No	No	No	No	Yes	No	No	No	No	
868A	CM17	No	Yes	No	No	No	No	No	Yes	No	No	No	No	

Foot/ Machine Setting		Clear-view foot (L)						Clear-view foot (M)						Remarks
		Straight Stitch 1	Straight Stitch 2	Straight Stitch 3	Straight Stitch 4	ZigZag Stitch 1	ZigZag Stitch 2	Straight Stitch 1	Straight Stitch 2	Straight Stitch 3	Straight Stitch 4	ZigZag Stitch 1	ZigZag Stitch 2	
859A	HMC12000	No	No	-	-	No	No	Yes	No	-	-	Yes	No	
861A	MC9900	No	No	-	-	No	-	-	-	-	-	No	-	Zigzag stitch1: Zigzag
861AL	MC9850	No	No	-	-	No	-	-	-	-	-	No	-	
862A/A2/A3	HMC15000	No	No	-	-	No	No	Yes	No	-	-	Yes	No	
862F	HMC14000	No	No	-	-	No	No	Yes	No	-	-	Yes	No	
862SA	SKYLINE S9	No	No	-	-	No	No	Yes	No	-	-	Yes	No	
863AU	SKYLINE S7	No	No	-	-	No	No	Yes	No	-	-	Yes	No	
865C	HMC9450QCP	No	No	-	-	No	No	Yes	No	-	-	Yes	No	
865A	HMC9400QCP	No	No	-	-	No	No	Yes	No	-	-	Yes	No	
867A	CM7P	No	No	-	-	No	No	Yes	No	-	-	Yes	No	
867C	CM8P	No	Yes	No	No	No	No	No	Yes	No	No	No	No	
867CL	CM6	No	Yes	No	No	No	No	No	Yes	No	No	No	No	
869A	HMC9480QCP	No	Yes	No	No	No	No	No	Yes	No	No	No	No	
869AL	HMC9410QC	No	Yes	No	No	No	No	No	Yes	No	No	No	No	
868A	CM17	No	No	No	No	No	No	Yes	Yes	No	No	Yes	No	

BOBBIN HOLDER FOR FREE QUILTING AND HAND-LOOK STITCHING



Couple the convertible FMQ foot with this handy bobbin holder preset with lower tension to make it even easier to achieve even tension control.

200-445-007	A*1 C*2 N*3 OP*4Q		BP
202-006-008	D		BP
202-433-008	A*5 N*6 P*7		BP

*1 excl. MC1000 *2 also MC6500P, DC6030, 4120QDC and 3160QDC *3 excl. CM17
 *4 excl. CM8P, CM7P, CM6 *5 For use with MC1000 only *6 For use with CM17 only
 *7 For use with CM8P, CM7P, CM6 only

FREE MOTION COUCHING FOOT SET



Enjoy embellishing your work with cords, strips and yarns by free-motion stitching. Zigzag stitch makes it easy to sew on any line or shape precisely. Two different feet are included to match material thickness.

202-110-006	A C	NOPQ	BP
-------------	-----	------	----

BORDER GUIDE FOOT



Create evenly spaced rows of decorative stitching with this border guide set. The horizontal red line matches up the needle drop of each row and the vertical red lines allow accurate positioning of one row with another.

<https://youtu.be/jkEzLKPstOE>



200-434-003	A CDEF		BP
202-084-000		NOPQ	BP

BUTTONHOLE STABILIZER PLATE



With the buttonhole foot R attached to the buttonhole stabilizer plate, the machine feeds various kinds of fabric and uneven layers more smoothly instead of eating the fabric or causing the needle to stick in position.

<https://youtu.be/Kyay3rGeJSo>



200-428-004	A CDE		BP
-------------	-------	--	----

LARGE BUTTONHOLE FOOT AND STABILIZER PLATE



The size of a buttonhole is automatically set by placing a button in the rear of automatic buttonhole foot LR. The button holder of the foot takes a button sizes of 2.5 cm (1") to 5.0 cm (2") in diameter. The stabilizer plate holds and supports the fabric so it is very helpful when sewing buttonholes over the hem of thick fabrics.

202-199-009		NOPQ	BP
-------------	--	------	----

RIBBON SEWING GUIDE

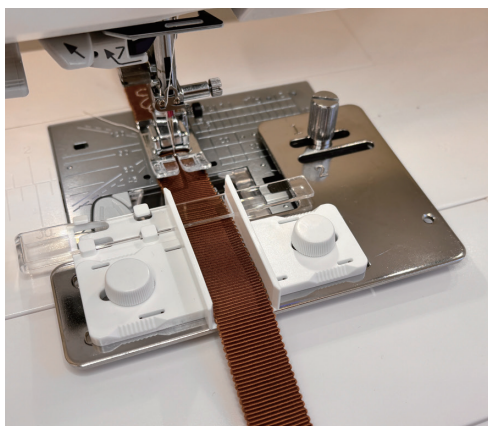

Create original ribbons by adding decorative stitching or lettering. The guide's design ensures easy attachment and automatic centering, while the transparent stabilizer bar provides perfect control. Add originality to projects and make the most of your machine's decorative stitches.

200-444-408	A CDEF	NOPQ	BP
-------------	--------	------	----

FRINGING FOOT

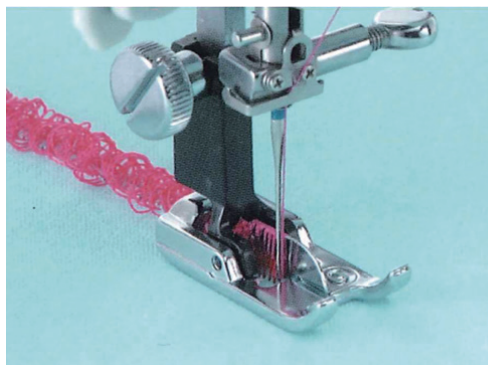

The fringing foot is designed for fagoting and sewing thread fringe. This decorative touch is especially effective in applique work. The foot has a small divider in it so that when you make a wide zig-zag stitch, you will wind up with a very large loop. Then simply cut the loop close to one side of the stitches, whichever side you want the fringe to be free on, and you'll have made your own thread fringe!

200-016-108	A C		CB
200-017-109	DEF		CB

EDGE GUIDE FOOT



The guide of this foot aligns edges/seams of fabric so that neatly parallel edge stitching and topstitching can be achieved with ease. Adjust the guide by turning the screw to match the edge/seam precisely.

<https://youtu.be/RA7rexcSbDY>



202-147-002	A CDEF		BP
202-100-003		NOPQ	BP

CIRCULAR ATTACHMENT



The circular attachment is the ideal attachment for sewing circles using either straight stitch, zigzag, decorative stitches or even lettering. Circles up to 26 cm in diameter are stitched perfectly using this popular attachment so essential for craft and decorative work.

Part Number	Package	Remarks	Compatible Models						
			Harmony 4045/4052	6019QC 6125QC	FD216/212/206 Sew Mini Platinum	M30A	3160QDC 2160DC 2030DC	4120QDC 5120QDC 4300QDC	TS100Q TS200Q
202-106-009	BP	Easy Set Bobbin System is not supported	502	503	508	805	808A/D/F/S/X	809A/AS	811A
			6260QC	MC6600P MC6500P	HMC8900QCP HMC8200QC	HMC12000	MC11000		
			845	846A/F	858F/G	859A	860		
202-107-000	BP	Easy Set Bobbin System is not supported	MS5027 MS5021 CS5031 SC5021	Easy Jeans 22 My Style 22	Jem Gold	Jem Gold2	MyExcel 4014/4018 4023/4123	HD2200 MyExcel 18/23	Décor 5124 5024 5018
			505	654	660	661	751	753	757
			Jem Platinum	DC4030	MC8000	MC9000	MC5700 MC5000	MC3500/3000	MC4800
			806	807	830	832	834	840	841
			DC4100	DC3018 DC3030 DC3060 DC8350	MC5200	MC4900	MC10000 MC10001	MC9500	MC9700
842	843	844	847	850	853	857			
202-135-007	BP	Metal Needle Plate with Easy Set Bobbin System is required	5300QDC 5270QDC SEWLA	M50QDC M100QDC M200QDC	Sewist 780DC 740DC	MC1000	HMC8900QCP SE	HMC8200QCP SE	MC9900 MC9850
			809AU/AU2/F	812	814	819	858F2	858G2	861
			HMC14000 HMC15000 SKYLINE S9	SKYLINE S3/S5/S6/S7	HMC9450QCP HMC9400QCP	MC6700P MC6650	HMC9480QCP HMC9410QC	CM8P CM7P CM6	CM17
			862A2/A3/S	863	865	866	869	867	868

BOBBIN HOLDER (high tension for embroidery use)



This bobbin holder creates easy-to-adjust thread tension when embroidering with non-Janome bobbin thread. The bobbin holder is marked with a YELLOW dot for identification.

202-134-006	A*1 B*2	N*3 O		BP
627-569-704	B*4			NP

*1 excl. MC1000 *2 MC350E only *3 excl. CM17 *4 For use with MC300E, MC200E

QUILT BINDER SET



Use the quilt binder set to produce 1/2 inch binding which can handle quilt fabric and other thick fabrics. Adjust the two upper screws to align the binding's top and bottom folds with the needle for extra precision. The set creates straight line binding for large quilts and also adds an eye-catching accent to any small items such as placemats and hot pads.

846-421-007	A*1C		BP
202-211-008		NOPQ	BP

*1 For use with MC11000 only.

FLOWER STITCHER



Even when using sewing machines without a large number of stitches, this attachment will allow you to produce unique and pretty flower designs and also eyelets, with ease.

202-261-003	DEF		BP
-------------	-----	--	----

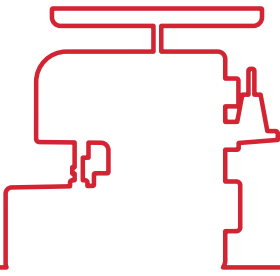

OVERLOCKER ACCESSORIES

Janome overlockers are known for their ease of use and beautiful serging results. Specialized overlocker feet and accessories are designed to give you the effect you want even on stretchy and thin fabrics.

CORDING FOOT (A)



With the rolled hem facility on your machine you can make great use of the cording foot A. This foot is ideal for bridal and evening wear and allows you to insert fine fishing line while rolling the edge of your material giving you a beautiful firm but flexible finish.

202-034-005	H		BP
-------------	---	--	----

CORDING FOOT (B)



Used in conjunction with the narrow hem, the cording foot B allows you to insert decorative cording as you stitch. This will give fine beautiful finished edges to table and other linens.

202-035-006	H		BP
-------------	---	--	----

TAPING FOOT WITH REEL



This attachment consists of a taping foot and a tape reel and is useful when sewing garments in knit or stretch fabric. It will help to feed seam binding tape when sewing shoulder seams and armholes to prevent stretching in these areas.

202-033-004	H*1		NP
-------------	-----	--	----

*1 excl. 234, 234D, AT2000DP

BLIND STITCH FOOT



Blind hemming is never an easy technique and demands practice and patience. It is possible to use your overlocker to blind hem and the blind stitch foot is equipped with a guide to help keep your stitching straight.

https://youtu.be/_JLGGCpytX0



202-040-004	H		BP
-------------	---	--	----

ELASTIC GATHERING ATTACHMENT



Stitching on elastic can sometimes be a little tricky especially when you have to stretch your elastic to size. The elastic foot helps make this technique a little easier to handle.

202-523-006	H*1		BP
202-037-008	H*2		BP

*1 excl. ML134D, ML234D, ML534D

*2 excl. ML134D, ML234D, ML534D, ML454D Sailing Line, ML554D Sailing Line, ML654D Sailing Line

BEADING FOOT



The beading attachment comprises a special sewing foot and guide enabling you to sew strung beads onto the edge of your fabric. Especially attractive for bridal wear.

202-041-108	H*1		BP
-------------	-----	--	----

*1 excl. 134D, 234, 234D, 534D

PIPING FEET



If ready made piping is not available or if you just want to make your own, the piping foot is ideal, making the task quick and easy. The piping foot is available in two sizes: 1/8 inch and 3/16 inch.

202-039-000	H*	SET OF TWO FEET (1/8 inch and 3/16 inch)	BP
-------------	----	---	----

*3/16 inch foot not compatible with 134D, 234, 234D, 534D

CLOTH GUIDE



As its name suggests, this guide helps keep your seams straight as you sew. Especially useful on flatlock seams and other seams where the knife is lowered.

202-525-008	H*1		BP
202-038-009	H*2		BP

*1 excl. ML134D, ML234D, ML534D

*2 excl. ML134D, ML234D, ML534D, ML454D Sailing Line, ML554D Sailing Line, ML654D Sailing Line

GATHERING ATTACHMENT



This attachment creates wonderful even gathers. Especially useful when sewing large amounts of fabric, i.e. bed linens and bridal gowns. With the help of this super attachment you can also gather and sew onto a flat piece of fabric in one easy operation.

<https://youtu.be/TARt9Xh536s>



202-036-100	H*1		BP
-------------	-----	--	----

*1 excl. 134D, 234, 234D, 534D

WASTE CHIP BOX



202-456-409	H*1	1/pkg	CB
202-456-708	H*1	10/pkg	CB
202-456-801	H*1	20/pkg	CB

*1 For use with 8002D, 9102D, ML454D



COVER STITCH MACHINE ACCESSORIES

Janome has developed a number of accessories to use with the CoverPro series of cover stitch machines. These accessories make it even easier to create beautiful garments from knits and other stretch fabrics.

CLEAR VIEW COVER STITCH FOOT



The clear view foot gives you a better view of what you are sewing. It is especially useful for decorative topstitching and can also be used with other attachments such as the hemming guide to match up the end of a hem seam with its start for a beautiful finish. Handy markings on the front edge of the foot correspond with needles for perfect stitch alignment.

795-818-107	I	for 3 needles	BP
795-821-103	I	for 2 needles	BP

HEM GUIDE



Type 1

The Hem Guide Type 1 folds over a consistent width of fabric for creating cover stitch hems, resulting in straighter hems. The Hem Guide also aids in attaching lace in garment and home decor applications. The guide allows you to create 5/8 inch - 1 3/4 inch hems.

Type 2

The Hem Guide Type 2 folds over a consistent width of fabric for you, making it easy to form hems, cuffs and other finished edges. When sewing the hem of a tubular item such as a skirt, you can press the release button as you near the finish to release the guide and then finish the rest of the hem.

795-803-109	I	Type1	BP
795-839-104	I	Type2	BP

ELASTIC GATHERING ATTACHMENT



The elastic gathering attachment allows easy attachment of elastic tape for waists and cuffs, which is especially useful for making undergarments and children's clothing. The wide workspace of the CoverPro means you can even add a bit of elastic in the middle of a garment, for example, to the waist of a dress.

795-816-105	I	narrow (6 - 8.5 mm)	BP
795-817-106	I	wide (9 - 13.5 mm)	BP

CENTER GUIDE FOOT



The center guide foot is used for lining up the center of a two or three-needle stitch with a previously sewn seam. This attachment is especially useful on sportswear and allows you to tack down already sewn seams, give extra strength to seams that come under strain or simply give a finished decorative effect.

795-819-108	I	for 3 needles	BP
795-820-102	I	for 2 needles	BP

ADJUSTABLE SEAM GUIDE

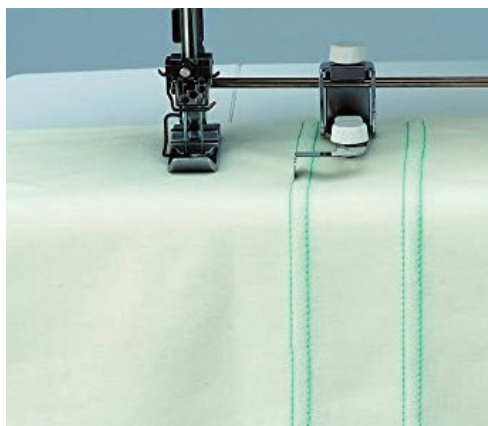

This seam guide is used to sew perfectly placed seams with accurate spacing between the lines.

795-806-102	I		BP
-------------	---	--	----

TAPE BINDER



The tape binder is used for finishing and covering the raw edges of stretch fabrics. The binder folds the fabric you wish to use as tape around the raw edge as you sew, allowing you to make beautifully finished necks and arm holes and bind any raw edge with ease.

Contents

- Binder and binder plate
- Binder foot
- Screw

<https://youtu.be/ntyfWtXfLRs>



795-838-103	I	for 3 needles (32 mm/8 mm)	BP
795-844-009	I	for 3 needles (42 mm/12 mm)	BP
795-840-108	I	for 2 needles (32 mm/8 mm)	BP
795-843-008	I	for 2 needles (42 mm/12 mm)	BP

STEP 1



Insert the fabric to be used as tape through the tape guide.

STEP 2

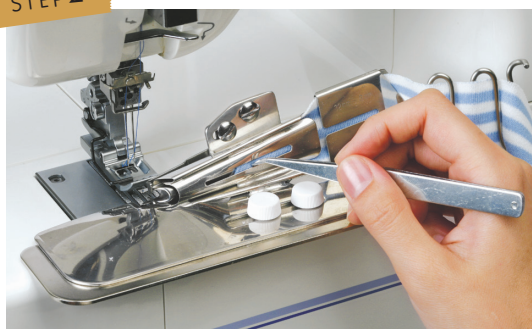

Guide the tape through the tape guide by gently pulling the end with the tip of the tweezers.

STEP 3

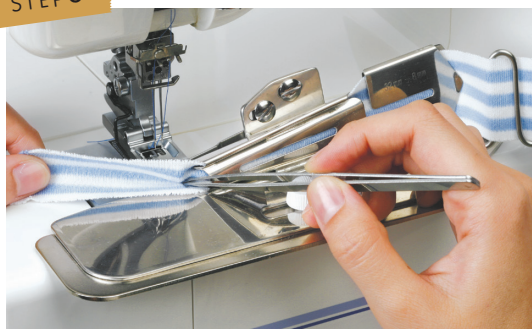

Pull out the end while using the tweezers tip to help insert the tape between the upper and lower guides at the end of the tube, and then slide the tape under the presser foot.

TAPE BINDER AND BINDER FOOT WITH GUIDE

This binder set can be used to create a beautiful binder finish like on ready-made T-shirts.

It is the most popular set among optional attachments for cover stitch sewing machines.



202-327-008	I	Tape Binder (Double Fold 8mm) and Binder Foot with Guide (finished with 8 mm for 32 mm tape) *Use only the right needle.	BP
202-328-009	I	Wide Tape Binder (Double Fold 12 mm) and Binder Foot with Guide (finished with 12 mm for 42 mm tape) *Use only the right and center needles.	BP

BINDER FOOT WITH GUIDE

This foot gives you a better view and guide is added for ease of use.



796-402-004	I		NP
-------------	---	--	----

TAPE STAND

As the tape can be supplied at the same height to the tape guide of the tape binder by using this tape stand with the tape binder, it feeds smoothly even when using very soft fabric allowing beautiful finishes to be achieved.



202-323-004	I		BP
-------------	---	--	----

BIAS TAPE GUIDE AND BELT LOOP FOLDER



This attachment can be used in two ways: as a "Bias Tape Guide" that can guide bias tape (single fold) and sew it on to knit fabric, and as a "Belt Loop Folder" that can make belt loops from fabric tape. This attachment is useful for creating various types of sewing work.

202-464-008	I		BP
-------------	---	--	----



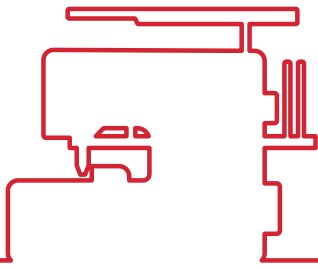

PROFESSIONAL OVERLOCK and COVER STITCH MACHINE ACCESSORIES

Ready to wear details and decorative accents are easily duplicable with Janome's combined overlock and cover stitch machine accessory range. Create the look you want the way you want it.

GATHERING FOOT



With the gathering foot it's easy to create the gather you want. The bottom fabric is gathered, seamed and overcast to a flat top fabric all in one easy operation.

200-807-104	M	NP
-------------	---	----

BLIND STITCH FOOT

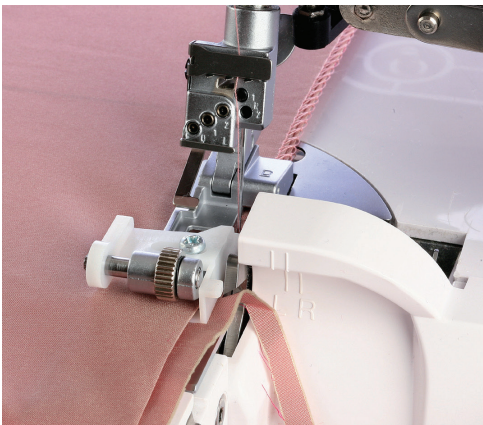

The adjustable guide on the blind stitch foot ensures that any weight of fabric is trimmed, overlocked and invisibly hemmed in one quick step. Change the stitch and it becomes a wonderful guide for decorative pintucks, lacy fagoting or flatlocking as seen in ready to wear.

200-806-103	M	BP
-------------	---	----

BEADING FOOT



Beaded trims add that special touch to any project. Deep grooves on the bottom of the pearl foot guide strands of pearls or beads perfectly into place and are secured with a flatlock stitch.

200-809-106	M	BP
-------------	---	----

BIAS TAPE FOOT

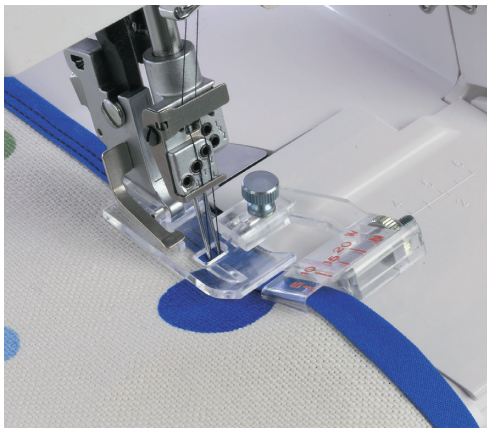

This adjustable foot allows you to attach 10 mm to 40 mm wide bias tape. Creating the look you want has never been easier.

200-810-100	M	BP
-------------	---	----

BELT LOOP FOOT



Easily duplicate the belt loops found in the garment industry using a wide or triple cover hem stitch. This foot automatically folds under bias strip edges for belt loops, decorative accents, button loops, narrow straps, etc. The possibilities are limited only by your imagination.

200-808-105	M coverhem only	NP
-------------	-----------------	----

COVER HEM FOOT, LACE ATTACHMENT, HEM & WRAPPED EDGE GUIDES

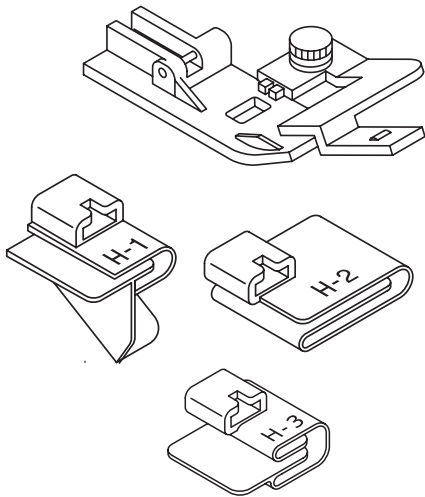

This set will save you a lot of time and trouble by making light work of hems. It offers three different ways to finish the edges of fabric, whether it's making a basic hem, decorating a hem with lace or creating a bias tape finish. Use for a multitude of projects.

200-801-407	M	coverhem only	BP
-------------	---	---------------	----

COVER HEM FOOT AND LACE ATTACHMENT

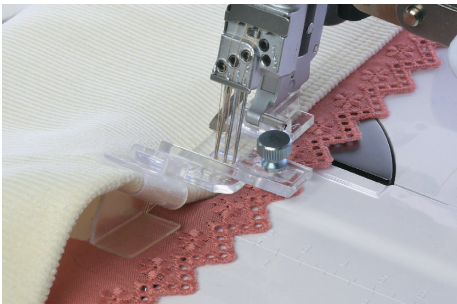

Efficient and clever, this guide folds perfect 6 mm (1/4 inch) edges. At the same moment it's hemming, it attaches lace or trim placed underneath. Use with the cover hem foot.

COVER HEM FOOT AND HEM GUIDE

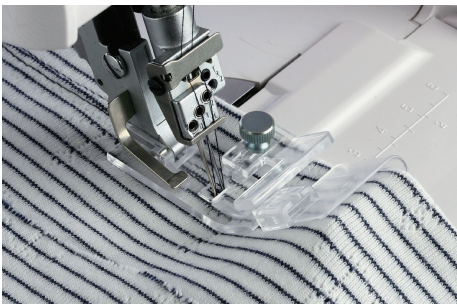

Hem edges evenly without measuring, pinning or pressing. Simply insert the fabric and the guide automatically folds and creates a 2.5 cm (1 inch) hem. Use with the cover hem foot.

COVER HEM FOOT WRAPPED EDGE GUIDE



This guide creates the look of bias tape. In addition, it also attaches pre-made bias tape. Hem edges evenly without measuring, pinning or pressing and duplicate ready-to-wear details easily.

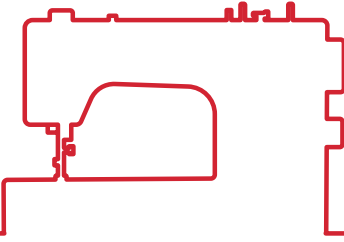

HIGH SPEED MACHINE ACCESSORIES

Janome high speed sewing machines sew at a maximum 1,600 stitches per minute, the fastest on the market.

Everything on these sewing and quilting machines is built for high quality stitches at professional speeds, including the specialized accessories and presser feet.

ULTRA GLIDE FOOT



Molded from a special resin for easy sewing of fabrics that might stick to a metal foot, the ultra glide foot is perfect for sewing ultra suede, vinyl and imitation leather.

767-404-028	J	BP
-------------	---	----

HD ROLLER FOOT



An innovative new foot that can smoothly control materials such as leather and vinyl which are prone to catch. When using this foot, the base of the needle is clearly visible, making your work easier.

202-418-007	A C	J NOPQ	BP
-------------	-----	--------	----

NARROW STRAIGHT STITCH FOOT



This foot is only 2 mm wide from the needle drop to the edge of the foot making it convenient for narrow topstitching especially on areas such as collars and pockets.

767-406-019	J		BP
-------------	---	--	----

STRAIGHT STITCH FOOT AND NEEDLE PLATE FOR FINE FABRICS



The specialized foot and needle plate work together to provide optimal feeding of fine fabrics.

767-405-007	J		BP
-------------	---	--	----

VELVET FOOT



The velvet foot only slightly touches the needle plate when the foot is lowered to obtain perfect sewing without bruising the specialty fabrics.

767-407-102	J		NP
-------------	---	--	----

1/4 INCH SEAM FOOT



The side guide allows you to sew a 1/4 inch seam allowance quickly and accurately. Great for piecing quilts and topstitching.

767-820-105	J	BP
-------------	---	----

DITCH QUILTING FOOT



Use this foot for perfect placement when stitching in the ditch. The guide follows the seamline keeping the stitch line perfectly straight.

767-824-109	J	BP
-------------	---	----

HEMMER FOOT



The hemmer foot can be sewn into the rolled hems with constant width.

761-172-004	J	NP
-------------	---	----

EVEN FEED FOOT



The even feed foot walks over fabric to assist with smooth feeding. Fabric can be sewn without puckering as the fabric is gripped and fed by both the upper and lower feed dogs. This foot has been specially designed for durability and to work at the high speeds of the 1600 series.

767-403-016	J		BP
-------------	---	--	----

DARNING FOOT WITH DARNING PLATE



The spring loaded foot can be used for free motion stippling, quilting and free form monogramming. The darning plate is placed over the existing needle plate to cover the feed dogs.

767-827-009	J		BP
-------------	---	--	----

TAPING FOOT



Use this foot for attaching tape to the edge of fabrics. Adjust the needle drop position with the thumb screw. Guide the fabric with the left hand and tape with the right hand.

767-412-018	J		BP
-------------	---	--	----

ADJUSTABLE ZIPPER FOOT



This foot can be set to sew on each side of the zipper by adjusting the position of the foot and tightening the thumb screw. Also great for sewing close to piping.

767-408-011	J		BP
-------------	---	--	----

CONCEAL® ZIPPER FOOT



This foot can be used for placement of invisible zippers. The grooves underneath accommodate the zipper teeth and hold them in place while you stitch.

767-410-016	J		BP
-------------	---	--	----

CONCEAL is a registered trademark of YKK Corporation.

ADJUSTABLE SEAM GUIDE



This seam guide is used to sew perfectly placed seams with accurate spacing between the lines.

767-411-017	J		BP
-------------	---	--	----

CONVERTIBLE FREE MOTION QUILTING FOOT SET

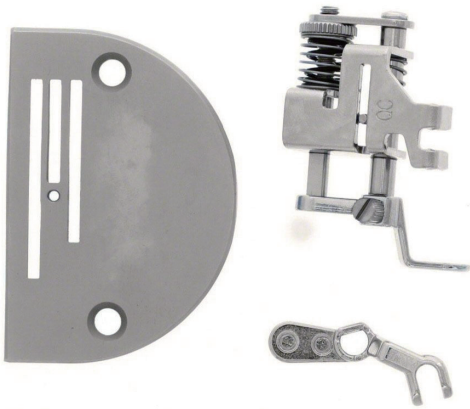

An exciting free-motion quilting presser foot set for the straight stitch machine. The feet are streamlined for improved visibility and a darning plate is also provided for table top free-motion quilting. The industrial construction reduces vibration and provides professional-level durability.

767-433-004

J

BP



For general use and especially well suited for lace and other catchable fabrics.



Also for general use, but the open-toe design provides greater visibility around the needle to assist in the formation of a precise design.

FREE MOTION FRAME QUILTING FEET SET

This set has been specifically designed to support quilters who use quilting frames with the 1600P series. The set consists of a 1/4 inch ruler foot and an open-toe frame quilting foot.



767-434-005

J

BP



This open-toe foot has an opening that faces sideways to provide a clear view of your work when standing at the handles of a quilt frame.



The 1/4 inch ruler foot has a high 'heel' and 1/2 inch diameter for free-motion quilting with 1/4 inch thick quilt rulers and long arm quilting templates.

1/4 INCH RULER FOOT SET

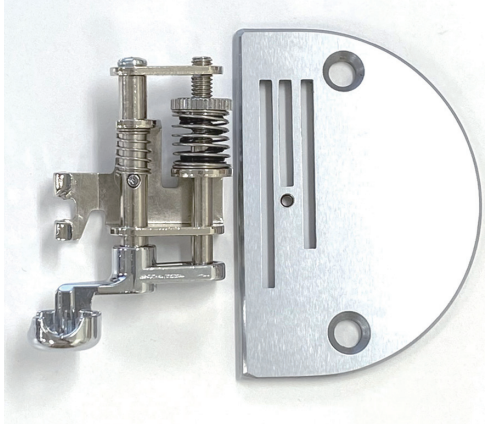

The 1/4 inch ruler foot was specifically designed to use with quilting rulers for ruler work. The key point of the foot is the 1/4 inch cup height which moves smoothly alongside the quilting ruler without allowing the ruler to slide over or under the foot. The needle drops a 1/4 inch away from the ruler to create the quilting line.

* This set includes a needle plate.

767-441-005	J		BP
-------------	---	--	----

MISC. ACCESSORIES

From basic accessories like needles, bobbins and bobbin cases to items such as spool stands which expand the creative possibilities of your sewing machine, Janome is dedicated to providing you with high quality accessories that are easy to use.



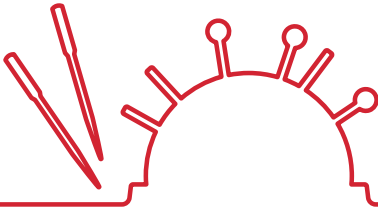

NEEDLES

No matter how advanced or sophisticated the sewing machine has become, the basic principle of selecting the correct needle to be used must still apply. Quite simply, the finer the fabric the finer the needle, the heavier the fabric the heavier the needle, but whether fine or heavy it is important to replace your needles regularly.

ASSORTED SEWING NEEDLES



Contents

- Blue Tip needle x 1
- #75/11 regular type needle x 2
- #90/14 regular type needle x 2

200-135-001	ABCDEFG	NOPQ		BP
-------------	---------	------	--	----



Contents

- Blue Tip needle x 2
- Purple Tip needle x 1
- Red Tip needle x 1
- Twin needle x 1

859-856-005	A CDE F	NOPQ		NP
-------------	---------	------	--	----



Contents

- Blue Tip needle x 1
- #75/11 regular type needle x 2
- #90/14 regular type needle x 1
- Twin needle x 1

820-827-007	A CDE F	NOPQ		NP
-------------	---------	------	--	----

BLUE TIP NEEDLES



The Blue Tip needle, a Janome exclusive, is a size #75/11 needle and is our best "all purpose" needle for both machine embroidery and general sewing including the sewing of knit fabrics.

It features a ball point tip* which helps to create neat and tidy stitches.

200-346-007	ABCDEFGHIH	NOPQ		BP
-------------	------------	------	--	----

PURPLE TIP NEEDLES



The purple tip needle is a #90/14 size needle that prevents skipped stitches in heavy fabrics including knits in ordinary sewing and when embroidering. It features a ball point tip* which helps to create neat and tidy stitches.

Uses -

- Embroidery with high density designs and/or thick fabrics
- Use with fluffy threads like cotton
- Quilting through multiple layers
- Normal sewing for shrink fabrics such as knits and tricot or synthetic fabrics such polyester

202-122-001	ABCDEFGHIH	NOPQ		BP
-------------	------------	------	--	----

BALL POINT NEEDLES



This pack contains 2 size #11/75 and 3 size #14/90 ball point needles. The ball point needle is made especially for stretch and elastic materials and knit fabrics, and is also ideal for overlock machines.

784-860-100	ABCDEFGHIH	NOPQ		NP
-------------	------------	------	--	----

*The ball point tip is especially useful when sewing knitted fabric and synthetic fabric as it prevents fabric thread breakage.

RED TIP NEEDLES

The red tip needle is a #90/14 size needle and is for general sewing and for embroidery of medium to heavy fabrics.



990-314-109	ABCDEFG	NOPQ		BP
-------------	---------	------	--	----

TOP STITCH NEEDLES

The top stitch needles has a large eye and a wide groove to accommodate heavy top stitching thread.



990-500-000	ABCDEFG	NOPQ	Assorted #11/75 & #14/90 (5/pkg)	NP
990-511-000	ABCDEFG	NOPQ	#11/75 (5/pkg)	NP

CUTWORK NEEDLE SET



This set contains 4 color-coded needles with the following cutting angles:

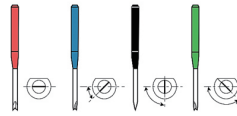

202-200-004	N*1	BP
-------------	-----	----

*1 excl. HMC12000

CUTWORK NEEDLE HOLDER



The Cutwork Needle Holder allows you to safely replace the Cutwork needles without injuring yourself with the tip of the Cutwork needle.

862-402-301	N*1	NP
-------------	-----	----

*1 excl. HMC12000

FM725 CHANGEABLE NEEDLE UNIT



This item is multiple needle units to deal with a variety of felting situations.

725-822-004	K		BP
-------------	---	--	----

FM725 FIXED FIVE FELTING NEEDLE UNIT



725-607-104*	K		NP
--------------	---	--	----

* In a plastic case

FM725 FIXED SINGLE FELTING NEEDLE UNIT



725-810-009*	K		NP
--------------	---	--	----

* In a plastic case

FM725 NEEDLE REFILLS



725-811-000*	K	3/pkg (single needle refills)	NP
725-829-001*	K	5/pkg (single needle refills)	NP
725-807-003*	K	10/pkg (single needle refills)	NP
725-831-006*	K	10/pkg (fine needle refills)	NP

* In a plastic case

Model	Needle Type	Part Number	Category	Package
Ball Point for Sewing machines and Overlockers	HA15x1SP Ball point assorted (5/pkg)	990-200-000	ABCDEFGHIH NOPQ	Needle case
	HA15x1SP Ball point size 75/11 (5/pkg)	990-211-000	ABCDEFGHIH NOPQ	Needle case
	HA15x1SP Ball point size 90/14 (5/pkg)	990-214-000	ABCDEFGHIH NOPQ	Needle case
CoverPro	Assorted 80/12 & 90/14 (5/pkg)	795-802-108	I	BP
	Size 80/12 (5/pkg)	795-807-103	I	BP
	Size 90/14 (5/pkg)	795-808-104	I	BP
1600P	HLx5 size 65/9 (10/pkg)	767-811-000	J	BP
	HLx5 size 75/11 (10/pkg)	767-812-001	J	BP
	HLx5 size 90/14 (10/pkg)	767-813-002	J	BP
	HLx5 size 100/16 (10/pkg)	767-814-003	J	BP
1600P-DB 1600P-DBX HD9P	DBx1 size 65/9 (10/pkg)	767-807-003	J	BP
	DBx1 size 75/11 (10/pkg)	767-808-004	J	BP
	DBx1 size 90/14 (10/pkg)	767-809-005	J	BP
	DBx1 size 100/16 (10/pkg)	767-810-009	J	NP
MB-4 MB-4s MB-7	Embroidery needles (10/Pkg)	770-811-000	L	Paper bag



OTHER ACCESSORIES

CLOTH SETTER for MC15000/MC12000/MC9900/MC550E/MC500E/MC400E



The patented Clothsetter has taken the guesswork out of positioning your embroidery. It ensures perfect placement of single designs on your project and multiple designs within the same hoop or between multiple hoopings. It's so easy, and only Janome has it. This dual function tool converts quickly into a large extension table providing extra support for all your large sewing and quilting projects.

859-439-101	B*1	NO	CB
-------------	-----	----	----

*1 For use with MC550E,MC500E,MC400E only

CLOTHSETTER TABLE - for MC11000



860-401-005	A		CB
-------------	---	--	----

CLOTHSETTER 10000

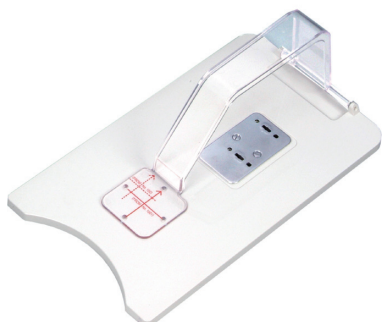

850-402-005	A		CB
-------------	---	--	----

UNIVERSAL TABLE STAND



Machines can sit in the table stably, with an insert plate filling the remaining space to provide a large, flat sewing surface. Not only is there more work space, but the table helps sewing progress smoothly by preventing excess fabric from dangling down and interfering with your work. It accommodates the knee lifter, contains a drawer and offers a generous formica-finished sewing surface.

494-710-003	A C	N*1 OP*2 Q	WITH DRAWER	CB
494-708-101	A C	N*1 OP*2 Q	WITHOUT DRAWER	CB

*1 excl. CM17 *2 excl. CM8P, CM7P, CM6

UNIVERSAL TABLE STAND FOR CONTINENTAL SERIES



494-719-002		N*1 P*2		CB
-------------	--	---------	--	----

*1 For use with CM17 only *2 For use with CM8P, CM7P, CM6 only

UNIVERSAL TABLE STAND FOR HIGH SPEED STRAIGHT STITCH MODELS



494-701-104		J		CB
-------------	--	---	--	----

DRAWER



494-708-204	A C	N*1OP*2 Q		CB
-------------	-----	-----------	--	----

*1 excl. CM17 *2 excl. CM8P, CM7P, CM6

INSERT PLATE

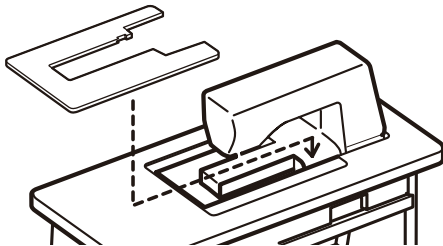

The insert plate fills the gap around the machine, ensuring a flush, flat work area that keeps fabrics from snagging or shifting during sewing. It should be used with the Universal Table Stand, and you can choose from various sizes of insert plates to fit your sewing machine.

494-401-101	C*1	N*2P*3	A FOR HORIZON SERIES	CB
494-402-102	C*4		B FOR MC6600P/MC6500P	CB
494-403-103	A		C FOR MC11000/MC11000SE	CB
494-405-105		O	D FOR MC9900	CB
494-406-106		N*5	E FOR MC15000	CB
494-407-107		N P Q	F FOR SKYLINE & ATELIER SERIES	CB
494-408-108		P*6	G FOR MC9450/MC9400	CB
494-712-005		P*7	H FOR MC6700P	CB
494-411-104		N*8P*9	K FOR CM17 & CM7P	CB

*1 For use with HMC7700QCP only
 *2 For use with HMC12000only
 *3 For use with HMC8900QCP, HMC8200QC only
 *4 excl. HMC7700QCP
 *5 For use with HMC15000, HMC14000 only
 *6 For use with HMC9480QCP, HMC9410QC, HMC9450QCP, HMC9400QCP only
 *7 For use with MC6700P only
 *8 For use with CM17 only
 *9 For use with CM8P, CM7P, CM6 only

SIDE TABLE STAND UNIT



This table is useful for any type of sewing. Place embroidery machines or overlockers on the table to secure more work space. Can also be used in combination with the universal table stand as a quilt side table and/or just to provide extra space for ironing, cutting fabrics or other activities. Comes with side pockets.

494-709-009	ABCDEFGHIJKLMNO P Q		CB
-------------	---------------------	--	----

BRUSH-OUT EMBROIDERY KIT



Brush-out embroidery uses yarn which can be fluffed up after sewing to create a soft, three-dimensional finish. The Brush-Out Embroidery kit includes a special foot and brush and is designed for use with the Brush-Out Embroidery Design CD-ROM from Stitchitize.

200-383-006	A*1 B*2		BP
-------------	---------	--	----

*1 excl. MC1000 and SKYLINE S3

*2 For use with MC350E, MC300E and MC200E only

EMBROIDERY COUCHING FOOT SET



The Embroidery Couching Foot Set includes 2 feet for using different yarn weights, a yarn guide arm that attaches to the extra spool pin hole on the top of the machine, plus instructions on How-to-use this foot set.

202-316-004	B*1		BP
202-297-008	N*2		NP

*1 excl. MC350E, MC300E and MC200E

*2 excl. HMC12000

LARGE EMBROIDERY DESIGN COLLECTION



Large Embroidery Collection comes with a USB flash drive containing 30 embroidery designs.

202-295-006	B*1 N*2		CB
-------------	---------	--	----

*1 excl. MC400E, MC350E, MC300E, MC200E, MC100E

*2 excl. SKYLINE S9

EMBROIDERY THREAD

No.1 200-920-001 CB



No.	Color
001	WHITE
002	BLACK
003	GOLD
201	PINK
202	VERMILION
203	ORANGE
204	YELLOW
205	DARK BROWN
206	BRIGHT GREEN
207	BLUE
208	PURPLE
209	PALE VIOLET
210	PALE YELLOW
211	PALE PINK
212	PEACH
213	BEIGE
214	BROWN
215	WINE RED
216	PALE SKY
217	SKY
218	YELLOW GREEN
219	OLIVE GREEN
220	SILVER GRAY
221	GRAY
222	OCEAN BLUE
223	BEIGE GRAY
-	BOBBIN THREAD

No.2 200-920-104 CB



No.	Color
224	BAMBOO
225	RED
226	GREEN
227	PALE AQUA
228	BABY BLUE
229	POWDER BLUE
230	BRIGHT BLUE
231	SLATE BLUE
232	NAVY BLUE
233	SALMON PINK
234	CORAL
235	BURNT ORANGE
236	CINNAMON
237	UMBER
238	BLOND
239	SUNFLOWER
240	ORCHID PINK
241	PEONY PURPLE
242	BURGUNDY
243	ROYAL PURPLE
244	CARDINAL RED
245	OPAL GREEN
246	MOSS GREEN
247	MEADOW GREEN
248	DARK GREEN
249	AQUAMARINE
-	BOBBIN THREAD

No.3 200-920-207 CB



No.	Color
250	EMERALD GREEN
251	PEACOCK GREEN
252	DARK GRAY
253	IVORY WHITE
254	HAZEL
255	TOAST
256	SALMON
257	COCOA BROWN
258	SIENNA
259	SEPIA
260	DARK SEPIA
261	VIOLET BLUE
262	BLUE INK
263	SOLA BLUE
264	GREEN DUST
265	CRIMSON
266	FLORAL PINK
267	WINE
268	OLIVE DRAB
269	MEADOW
270	MUSTARD
271	YELLOW OCHER
272	OLD GOLD
273	HONEY DEW
274	TANGERINE
275	CANARY YELLOW
-	BOBBIN THREAD

BOBBINS



These plastic bobbins can be used for Janome home use models. Replace any bobbin that is worn, cracked, or nicked; a damaged bobbin can cause sewing problems.

102-261-103	ABCDEFG	NO PQ	PLASTIC BOBBINS (single)	NP
200-122-005	ABCDEFG	NO PQ	PLASTIC BOBBINS (10/pkg)	BP
202-544-014	ABCDEFG	NO PQ	PLASTIC BOBBINS (500/pkg)	CB
202-545-015	ABCDEFG	NO PQ	PLASTIC BOBBINS (20 boxes of Part No. 202-544-014)	CB
761-094-115		J*1	METAL BOBBIN (single)	NP
767-860-107		J*2		NP
761-094-104		L*3		NP
770-591-001		L*4		NP

*1 excl. HD9P *2 For use with HD9P *3 For use with MB-4 *4 excl. MB-4

PINK BOBBIN



200-277-062	ABCDEFG	NO PQ		NP
-------------	---------	-------	--	----

BLUE BOBBIN



200-277-084	ABCDEFG	NO PQ		NP
-------------	---------	-------	--	----

BOBBIN CASES



Front and side-loading machines require a separate bobbin case which also acts to control the bobbin tension. Although not generally recommended, more advanced sewists like to adjust the lower tension to accommodate special threads, such as when using a handwound bobbin of thicker decorative thread. You can avoid tricky tension adjustments afterwards by having an extra bobbin case on hand specially adjusted for thicker or thinner threads.

647-515-006	G		HOUSEHOLD SEWING	NP
767-510-006		J*1	HIGH SPEED SEWING	NP
767-595-005		J*2		NP
770-578-002		L*3	MULTI-NEEDLE EMBROIDERY	NP
770-590-000		L*4		NP

*1 excl. HD9P *2 For use with HD9P *3 For use with MB-4 *4 excl. MB-4

SPOOL HOLDER (SPECIAL)



Have you had times when you're putting a long spool on the horizontal spool stand but the spool pin is short and the spool holder can't be attached?

Janome has come up with a solution for this by developing a new spool holder.

The "Spool Holder (special)" is specifically for long spools.

202-233-006	ABCDEFG	NOPQ		BP
-------------	---------	------	--	----

REMOTE THREAD CUTTING SWITCH UNIT



Cut threads by foot after sewing. A useful tool for when both hands are occupied, allowing you to focus on the fabric. Can also be helpful when the machine is placed on a quilt frame, making your work more efficient.

858-418-008		OP*1Q		CB
-------------	--	-------	--	----

*1 excl. MC8200QC

* Should be used with the large foot controller only. Not included in set (sold separately).

LARGE FOOT CONTROLLER



Now bigger and easier to use. As rubber covers the back face, it won't slip and is simple to operate. The larger surface facilitates a greater level of control.

858-417-007	A CD	NOPQ		CB
-------------	------	------	--	----

PIN CUSION



202-256-005	AC*1	DN*2	OP*3	Q*4		NP
-------------	------	------	------	-----	--	----

*1 excl. MC6600P, MC6500P *2 excl. CM17 *3 excl. MC6700P, CM8P, CM7P, CM6 *4 excl. MC6650



202-256-027	AC*1	DN*2	OP*3	Q*4		NP
-------------	------	------	------	-----	--	----

*1 excl. MC6600P, MC6500P *2 excl. CM17 *3 excl. MC6700P, CM8P, CM7P, CM6 *4 excl. MC6650



202-256-016	AC*1	DN*2	OP*3	Q*4		NP
-------------	------	------	------	-----	--	----

*1 excl. MC6600P, MC6500P *2 excl. CM17 *3 excl. MC6700P, CM8P, CM7P, CM6 *4 excl. MC6650



202-256-038	AC*1	DN*2	OP*3	Q*4		NP
-------------	------	------	------	-----	--	----

*1 excl. MC6600P, MC6500P *2 excl. CM17 *3 excl. MC6700P, CM8P, CM7P, CM6 *4 excl. MC6650

PROTECTIVE SHEET



A sheet to protect the stainless steel plate on the free arm top from scratches and damage. Being transparent, it doesn't interfere with the exterior design and allows the embossed measurement guide to still be used.

859-434-003	N*1		BP
-------------	-----	--	----

*1 For use with HMC15000 and HMC12000 only

NET



624-806-006	ABCDEFGHIJKLMNO		NP
-------------	-----------------	--	----

ACUSTITCH

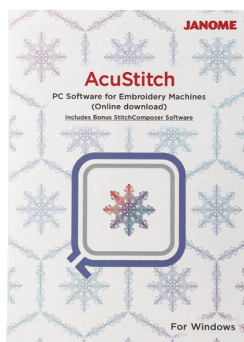

AcuStitch arranges stitch data in succession, helping you to create embroidery data for various shapes.

For more information,
please refer to the [JANOME BULLETIN](#).



202-532-008	A*1B*2	NO	Cardboard sleeve
-------------	--------	----	------------------

*1 For use with MC1000

*2 excl. MC350E, MC300E, MC200E

SEWING MAT



301-802-002	DEFGHI K M	445 mm x 325 mm (Horizontal rectangle)	NP
301-803-003	L	370 mm x 610 mm (Vertical rectangle)	NP

INTERLOCKING SEWING MAT



Expand the Interlocking Sewing Mat by fitting pieces together if you need a larger area (for example, when using the Extra Wide Table).

For more information, please refer to the [JANOME BULLETIN](#).



202-537-003	ABC J N*1 OP*2 Q	400 mm x 630 mm	NP
-------------	------------------	-----------------	----

*1 excl. CM17 *2 excl. CM8P, CM7P and CM6

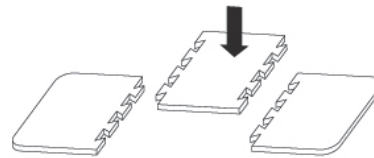

202-536-002	N*1 P*2	400 mm x 960 mm	NP
-------------	---------	-----------------	----

*1 For use with CM17 *2 For use with CM8P, CM7P and CM6

KNEE LIFTER



The knee lifter is extremely helpful when sewing patchwork, quilting, etc., since it allows you to handle the fabric while your knee controls the presser foot.

202-542-001	A C	OP*1Q	Plastic bag
-------------	-----	-------	-------------

*1 excl. HMC9450QCP, HMC9400QCP, CM8P, CM7P, HMC9480QCP, HMC9410QC and CM6

CARRYING BAG

These bags have all the sturdy features a traveling sewist needs: strong handles, accessory pockets and tons of space. Whether you're just going to sewing class or you're traveling across the country, you deserve a bag that fits your style.

Part Number	Package	Image	Size (cm)	Compatible models
			Width X Height X Depth	
655-811-206	CB		43 X 33 X 21	423S/415/405 3012/3016/3022 JR1012
				303/306/743
808-857-101	NP		42 X 32 X 22	Sewist 725S/721 230DC/360DC 5060QDC/5270QDC/DC3200/ DC7100/DC6030/SEWLA 5100/MOD-100Q M200QDC/M7200 Sewist 780DC/Sewist 740DC
808-817-017	CB			
808-817-110	CB			
785-823-300	CB		32 X 35 X 30	ML204D/990D 8002D 9102D ML213 ML454D Sailing Line ML644D/ML554D Sailing Line ML634D/1110DX/DreamLock70D/ EzyLock604D/ML654D Sailing Line ML844D/ML744D/ML734D AT2000DP
785-826-107	NP		32 X 35 X 30	

STRAIGHT STITCH NEEDLE PLATE

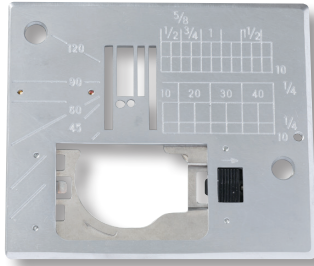

The straight stitch needle plate is designed with a round needle hole which offers the benefit of more support around the needle and is used in conjunction with the straight stitch foot.

Part Number	Package	Standard or Optional	Compatible models	Max. zigzag width	Needle Position	Easy Set Bobbin	Replacement	Remarks
503-820-008	NP	Optional	6125QC/6019QC	7 mm	L,M	No	Screw	
860-405-906	CB	Optional	MC11000/4300QDC/4120QDC/3160QDC/2160DC/ 2030DC/TS200Q/TS100Q 860/809/808/811	7 mm	L,M	No	Screw	Metal Needle Plate without Easy Set Bobbin System is required
809-833-012	NP	Optional	DC7100/DC7060/ DC6030/5300QDC/5270QDC/5060QDC/SEWLA Sewist 780DC/740DC/TS200Q/M200QDC 809/814/812	7 mm	L,M	Yes	Screw	Metal Needle Plate with Easy Set Bobbin System is required
200-088-101	NP	Optional	MC3000/MC4000/MC9000/MC9500/MC9700	7 mm	L,M	No	Screw	
846-833-109	NP	Optional	MC6600P	7 mm	L,M	No	Screw	
819-803-003	NP	Standard	MC1000	7 mm	L,M	Yes	Magnet type (Manual)	
861-801-013	NP	Standard Optional	MC9900 MC9850	9 mm	L, M	Yes	One-Touch	
862-817-118	NP	Standard	HMC8900QCP SE/HMC8200QCP SE/ SKYLINE S9/S7/S6/S5/HMC9480QCP/HMC9410QC/ HMC9450QCP/HMC9400QCP/MC6700P/MC6650	9 mm	L, M, R	Yes	One-Touch	
865-805-019	NP	Standard Optional	HMC9480QCP/HMC9450QCP/HMC9400QCP/MC6700P HMC9410QC/SKYLINE S9 ver.2.00 or later/MC6650	9 mm	L	Yes	One-Touch	HP Needle Plate
859-831-015	NP	Standard	HMC12000/HMC8900QCP/HMC8200QC	9 mm	L, M	No	One-Touch	
865-805-112	NP	Standard Optional	HORIZON Quilt Maker MC15000 HMC15000/HMC15000V2	9 mm	L	Yes	One-Touch	HP Needle Plate
862-817-015	NP	Standard	HMC15000/HMC15000V2/ HORIZON Quilt Maker MC15000/HMC14000	9 mm	L, M, R	Yes	One-Touch	
867-802-001	NP	Standard	CM6/CM7P/CM8P/CM17	9 mm	L, M, R	Yes	Magnet type (Automatic)	
867-803-002	NP	Standard Optional	CM7P/CM8P/CM17 CM6	9 mm	L	Yes	Magnet type (Automatic)	HP Needle Plate
867-405-000	BP	Optional	CM6/CM7P/CM8P/CM17	9 mm	L	Yes	Magnet type (Automatic)	HP Needle Plate and HP Foot
869-410-004	BP	Optional	HMC9480QCP/HMC9450QCP/HMC9410QC/ HMC9400QCP/SKYLINE S9 ver.2.00 or later/SKYLINE S7 Anniversary Edition/MC6700P/MC6650/HMC15000	9 mm	L	Yes	One-Touch	HP Needle Plate and HP Foot

OPTIC MAGNIFIER



When you need to get a closer view, attach the magnifier to make it easy to see the tiniest detail under the needle. Useful when threading, adjusting the position of the fabric, and carrying out detailed work.

Part Number	Package	Holder	Strength	Compatible Models	
				Optional Accessory	Standard Accessory
202-129-008	BP	Short	20	DC7100/DC7060/DC6030/5060QDC/DC3200/SEWLA	HMC12000
202-130-002	BP	Long	20/40/60	HMC14000*1 HMC9480QCP/HMC9410QC HMC9450QCP/HMC9400QCP HMC8900QCP/HMC8200QC/MC6700P MC9900/MC9850/MC6650/MC1000 SKYLINE S9/S7/S6/S5/S3 Sewist 780DC/740DC 4300QDC M200QDC/M100QDC/M50QDC TS200Q*2/TS100Q*2	HMC15000 5300QDC/5270QDC
202-400-006	BP	Long	20	Same as above	HMC14000
202-432-007	BP	Long	20/40/60	CM8P/CM7P/CM6	CM17

*1 Strength 20 is packed as a standard accessory. *2 Holder (#859-233-000) and Setscrew 3x10(#000-161-206) are required for TS200Q/TS100Q(811).

SKYLINE ACCESSORY CASE



Keep all the accessories for 9mm machines organized with this stylish 3-tiered accessory case.

Everything from bobbins to presser feet can be kept neat and clean in its own place.

863-406-010 For all SKYLINE models except S3

CB

EMBROIDERY HOOP



Part Number	Package	Hoop Name		Size (mm)	Compatible Models
				X X Y	
856-401-002	CB	Small		50 × 50	MC200E
850-803-000	CB	C	Free Arm	50 × 50	MC350E
850-406-009	CB	D	Giga	230 × 200	
819-401-007	CB	SQ10e	Square	100 × 100	MC1000/MC100E
819-402-008	CB	FA10e	Free Arm	100 × 40	MC1000/MC100E
819-403-009	CB	FA5e	Free Arm	50 × 50	MC1000/MC100E
864-839-008	NP	RE36b	Rectangular	200 × 360	MC550E(Standard Accessory)
864-403-009	CB	RE28b	Rectangular	200 × 280	MC550E/MC500E/MC450E
864-404-000	CB	SQ20b	Square	200 × 200	MC550E/MC500E/MC450E/MC400E
864-405-001	CB	RE20b	Rectangular	140 × 200	MC550E/MC500E/MC450E/MC400E
864-406-002	CB	SQ14b	Square	140 × 140	MC550E/MC500E/MC450E/MC400E
864-407-003	CB	RE10b	Rectangular	100 × 40	MC550E/MC500E/MC450E/MC400E
864-438-003	CB	SQ10b	Square	100 × 100	MC550E/MC500E/MC450E/MC400E
864-435-000	CB	ASQ18b	AcuFil Quilting Kit	184 × 184	MC550E/MC500E/MC450E/MC400E
864-402-008	CB	ASQ18b	AcuFil Quilting Kit	184 × 184	MC500E/MC450E/MC400E
861-803-509	NP	RE20a	Rectangular	170 × 200	SKYLINE S9/MC9900/MC9850
861-402-205	CB	FA10a	Free Arm	100 × 40	SKYLINE S9/MC9900/MC9850
860-427-007	CB	FA	Free Arm	50 × 50	MC11000SE
860-428-008	CB	MA	Macro	200 × 280	
860-421-001	CB	RE	Rectangular	140 × 200	
860-445-023	CB	ASQ	Professional Quilting Kit	180 × 180	
862-412-005	CB	ASQ22	AcuFil Quilting Kit	220 × 220	HMC14000/HMC12000
862-407-052	CB	RE18	Essential	140 × 180	HMC15000/HMC14000
770-487-704	NP	J1 No.11		30(diam.)	MB-7/MB-4S/MB-4 *Monogram Hoop Adaptor (770-482-008) is required when using hoops J1-J8
770-487-807	NP	J1 No.12		30(diam.)	
770-487-302	NP	J2 No.6		24 × 54	
770-487-900	NP	J3 No.13		64 × 28	
770-487-508	NP	J4 No.8		42 × 67	
770-487-209	NP	J5 No.3		46 × 46	
770-487-106	NP	J6 No.2		66 × 66	
770-487-601	NP	J6 No.9		66 × 66	
770-487-003	NP	J7 No.1		110 × 95	
770-487-405	NP	J8 No.7		120 × 121	
770-478-414	NP	S1:MB		37 × 59	MB-7/MB-4S/MB-4 *Socks Hoop Adaptor (770-657-006) is required when using hoops S1, S2
770-478-517	NP	S2:MB		28 × 50	
770-480-006	CB	Sock Hoop Kit			

Part Number	Package	Hoop Name	Required Hoop Size (mm)	Compatible Models
200-335-003	Plastic bag	Hat Hoop Insert (HH10b)	140 × 200	MC550E/MC500E/MC450E/MC400E/MC300E/MC350E MC9500/MC9700/MC11000SE
859-436-005	Plastic bag	Hat Hoop Insert	140 × 140	HMC15000/HMC14000/HMC12000
770-489-005	Plastic bag	Flat hat Hoop	Not required	MB-7/MB-4S/MB-4

Part Number	Package	Name	Required Hoop	Compatible Models
868-415-006	CB	Magnetic clamp attachments	ASQ27d	For use with CM17 Ver. 2.00 or later only

EXTRA WIDE TABLE



An Extra wide table fits snugly against your sewing machine, giving you a much larger work surface. Extra wide tables provide extra support for your sewing and quilting projects.

Part Number	Package	Compatible Models					
303-403-005	CB	423S/419S/415/405 303	523/3022 312				
306-502-004	CB	3012/3016/3022 306	311 311	FM-725 725C	JR1012 743		
725-813-002	CB	FM-725 725C	JR1012 743/744/746/305				
491-703-015	NP	HD2200 MyExcel 18/23 753	Décor 5124/5024/5018 757				
502-405-000	CB	Sewist 725S/721/709 507G/507F					
502-403-008	NP	FD216/212/206 Sew Mini Platinum 508A/D/X/FD	M30A 805A				
503-801-003	CB	6019QC/6125QC 503					
489-710-007	NP	HMC7700QCP (Standard Accessory) 858A	HMC8200QC/ HMC8200QCP SE 858G/G2	HMC8900QCP/ HMC8900QCP SE (Standard Accessory) 858F/F2			
491-701-013	CB	DC4030 807F	DC2019/DC2010/NEK-50 843S2	8077/Magnolia7330 843W	MC4800/MC4800QC 841A	NH8420 842H	DC3018 843H/C
491-701-091	CB	MC4900 847B	MC5200 844C				
819-404-206	CB	MC1000 819					
499-702-100	CB	HD9P/1600P 767					
808-401-003	NP	3160QDC/2160DC 2030DC 808A/D/F	4120QDC/4300QDC/5300QDC 5270QDC (Standard Accessory) 809A/AS/AU	DC7060/7100/6030 5060QDC (Standard Accessory) 809J2/J3/N/F	MOD100/50/30 811	M200QDC/M100QDC M50QDC 812	780DC/740DC 814
808-428-006	CB	3160QDC/2160DC 2030DC 808A/D/F	4120QDC/4300QDC/5300QDC 5270QDC (Standard Accessory) 809A/AS/AU	DC7060/7100/6030 5060QDC (Standard Accessory) 809J2/J3/N/F	MOD100/50/30 811	M200QDC/ M100QDC M50QDC 812	780DC/740DC 814
863-414-000	CB	MC9900 861	SKYLINE S9 862SA	SKYLINE S7/S6/S5/S3 863AU/863F/863A/863AL			
846-401-104	CB	MC6700P (Standard Accessory) 866A	MC6650 866D	MC6600P 846F	MC6500P (Standard Accessory) 846A		
865-806-009	NP	HMC9450QCP (Standard Accessory) 865C	HMC9400QCP (Standard Accessory) 865A				
869-412-006	CB	HMC9480QCP (Standard Accessory) 869A	HMC9410QC (Optional Accessory) 869AL				
868-404-013	CB	CM17 (Optional Accessory) 868					
867-806-027	CB	CM8P (Standard Accessory) 867C	CM6 (Optional Accessory) 867CL	CM7P 867A			
864-408-004	CB	MC500E/MC450E/ MC400E 864AU/A/AL					
864-408-015	CB	MC550E/MC500E MC450E/MC400E 864F/AU/A/AL					
770-814-003	CB	MB-4S/MB-4 770	MB-7 771				
202-438-106	CB	990 90th Anniversary 789	8002D 792	9102D 793	ML454D Sailing Line 779	ML213 790	AT2000DP 799
795-812-307	CB	CoverPro 2000CPX 796D	CoverPro 3000P 778				

SPOOL STAND



The two/five pin spool stand attaches easily to the back side of your machine. When using multiple colors of embroidery thread it makes for trouble-free embroidery, as it allows you to set out your colors as you sew.

Part Number	Package	Number of spool	Thread Guide	Compatible Models
202-513-003	CB	For Two Spools	Not Available	Oscillating hook models (Harmony2039/2049, 920, 1580LX, 311, 3012/3016/3022, JR1012, 1522)

Part Number	Package	Number of spool	Thread Guide	Compatible Models
859-429-005	CB	For Two Spools	Round X 1	HMC15000/HMC14000/HMC12000/MC9900/MC9850/HMC9480QCP/ HMC9410QC/MC9450/MC9400/SKYLINE S9/S7/S6/S5/S3
858-402-009	CB		Square X 1	HMC8900QCP/HMC8200QC/HMC7700QCP
859-429-016	CB		Round X 1 Square X 1	HMC15000/HMC14000/HMC12000/MC9900/MC9850/HMC9480QCP/ HMC9410QC/HMC9450QCP/HMC9400QC/HMC8900QCP/HMC8200QC/ HMC7700QCP/MC550E/MC500E/MC450E/MC400E/SKYLINE S9/S7/S6/ S5/S3/MC1000/MC100E
869-400-908	CB		Round X 1	HMC9480QCP/HMC9410QC *Belt cover side mounting type

Part Number	Package	Number of spool	Thread Guide	Compatible Models
852-406-005	CB	For Five Spools	Square x 1	MC350E
832-420-014	CB		Square x 1	MC10001/MC10000/MC9700/MC9500/MC9000/MC300E
860-406-000	CB		Square x 1	MC11000/MC200E
859-430-009	CB		Round x 1	HMC15000/HMC14000/HMC12000/MC9900/MC9850/HMC9480QCP/ HMC9410QC/HMC9450QCP/HMC9400QC/HMC8900QCP/HMC8200QC/ HMC7700QCP/MC550E/500E/450E/400E/SKYLINE S9/S7/S6/S5/S3/ MC1000/MC100E
868-405-014	CB		Not Available	CM17

202-513-003
For Oscillating hook models



869-400-908
For HMC9480QCP/HMC9410QC
*Belt cover side mounting type



I N D E X

JANOME QUALITY

ACUFEED 1/4 INCH SEAM FOOT AND NEEDLE PLATE (Dual feed 1/4 inch seam foot and needle plate)	9
ACUFEED 1/4 INCH SEAM FOOT(Dual feed 1/4 inch seam foot)	9
ACUFEED DITCH QUILTING FOOT(Dual feed ditch quilting foot)	10
ACUFEED FLEX PROFESSIONAL GRADE FOOT (Dual feed plus professional grade foot)	12
ACUFEED FOOT WITH FOOT HOLDER(Dual feed plus foot with foot holder)	11
ACUFEED OPEN TOE FOOT(Dual feed open toe foot)	9
ACUFEED QUILT PIECING FOOT(Dual feed quilt piecing foot)	9
ACUFEED STRAIGHT STITCH FOOT(Dual feed straight stitch foot)	10
ACUFEED ZIPPER FOOT(Dual feed plus zipper foot)	11
A.S.R.®	12

GENERAL SEWING MACHINES

1/4 INCH RULER FOOT	29
1/4 INCH SEAM FOOT	26
1/4 INCH SEAM FOOT (WITHOUT GUIDE)	26
3-WAY CORDING FOOT	24
9-HOLE CORDING FOOT	24
APPLIQUE FOOT	14
BEADING FOOT	24
BIAS TAPE ATTACHMENT	21
BINDER FOOT	17
BLIND HEM ATTACHMENT	21
BLIND HEM FOOT	19
BOBBIN HOLDER FOR FREE QUILTING AND HAND-LOOK STITCHING	32
BOBBIN HOLDER (high tension for embroidery use)	35
BORDER GUIDE FOOT	32
BUTTON SEWING FOOT	25
BUTTONHOLE STABILIZER PLATE	33
CIRCULAR ATTACHMENT	35
CLEAR VIEW 1/4 INCH SEAM FOOT	26
CLEAR VIEW QUILTING FOOT AND GUIDE SET	27
CONCEAL® ZIPPER FOOT	20
CONVERTIBLE EVEN FEED FOOT SET	28
CONVERTIBLE FREE MOTION QUILTING FOOT SET	30
CUSTOM CRAFTED ZIGZAG FOOT	17
DARNING FOOT	15
DITCH QUILTING FOOT	26
DITCH QUILTING GUIDE AND ADJUSTABLE QUILTING GUIDE SET	28
EDGE GUIDE FOOT	34
EVEN FEED FOOT WITH QUILTING GUIDE	28
FLOWER STITCHER	36
FREE MOTION COUCHING FOOT SET	32
FRINGING FOOT	34
GATHRING FOOT	17
HD ROLLER FOOT	16
HEMMER FEET SET	20
LAP-SEAM FOOT	18
LARGE BUTTONHOLE FOOT AND STABILIZER PLATE	33
LEFT BI-LEVEL FOOT	18
LONG QUILTING GUIDE BAR SET	29
OVERCASTING FOOT	19
OVEREDGE FOOT	19
PINTUCKING CORD GUIDE	23
PINTUCKING FEET	23
PIPING FOOT	22
PIPING FOOT (NARROW)	22
QUILT BINDER SET	36
RIBBON SEWING GUIDE	33

RIBBON/SEQUIN FOOT	25
RIGHT BI-LEVEL FOOT	18
ROLLED HEM FOOT	20
ROLLER FOOT	15
ROTARY EVEN FOOT	21
ROUND HEM FOOT	20
RUFFLER	22
SATIN STITCH FOOT	16
SLIDING BUTTONHOLE FOOT	25
SLIDING GUIDE FOOT	15
STRAIGHT STITCH FOOT	14
TAPING GUIDE FOOT	18
TRANSPARENT BUTTONHOLE FOOT	25
TRICOT FOOT	19
ULTRA GLIDE FOOT	16
ULTRA GLIDE NEEDLE PLATE & ULTRA GLIDE FOOT	16
WIDE ROLLED HEM ATTACHMENTS	21
ZIPPER FOOT	20

OVERLOCKERS

BEADING FOOT	39
BLIND STITCH FOOT	38
CLOTH GUIDE	39
CORDING FOOT(A)	37
CORDING FOOT (B)	37
ELASTIC GATHERING ATTACHMENT	38
GATHERING ATTACHMENT	40
PIPING FEET	39
TAPING FOOT WITH REEL	38
WASTE CHIP BOX	40

COVER STITCH MACHINES

ADJUSTABLE SEAM GUIDE	42
BIAS TAPE GUIDE AND BELT LOOP FOLDER	45
BINDER FOOT WITH GUIDE	44
CENTER GUIDE FOOT	42
CLEAR VIEW COVER STITCH FOOT	41
ELASTIC GATHERING ATTACHMENT	42
HEM GUIDE	41
TAPE BINDER	43
TAPE BINDER AND BINDER FOOT WITH GUIDE	44
TAPE STAND	44

PROFESSIONAL OVERLOCK

AND COVER STITCH

MACHINES

BEADING FOOT	47
BELT LOOP FOOT	47
BIAS TAPE FOOT	47
BLIND STITCH FOOT	46
COVER HEM FOOT, LACE ATTACHMENT,HEM & WRAPPED EDGE GUIDES	48
GATHERING FOOT	46

HIGH SPEED MACHINES

1/4 INCH RULER FOOT SET	55
1/4 INCH SEAM FOOT	51
ADJUSTABLE SEAM GUIDE	53
ADJUSTABLE ZIPPER FOOT	53
CONCEAL® ZIPPER FOOT	53
CONVERTIBLE FREE MOTION QUILTING FOOT SET	54
DARNING FOOT WITH DARNING PLATE	52
DITCH QUILTING FOOT	51
EVEN FEED FOOT	52
FREE MOTION FRAME QUILTING FEET SET	54
HD ROLLER FOOT	49

HEMMER FOOT	51
NARROW STRAIGHT STITCH FOOT	50
STRAIGHT STITCH FOOT AND NEEDLE PLATE FOR FINE FABRICS	50
TAPING FOOT	52
ULTRA GLIDE FOOT	49
VELVET FOOT	50

NEEDLES

ASSORTED SEWING NEEDLES	57
BALL POINT NEEDLES	58
BLUE TIP NEEDLES	58
CUTWORK NEEDLE HOLDER	60
CUTWORK NEEDLE SET	60
FM725 CHANGEABLE NEEDLE UNIT	61
FM725 FIXED FIVE FELTING NEEDLE UNIT	61
FM725 FIXED SINGLE FELTING NEEDLE UNIT	61
FM725 NEEDLE REFILLS	61
PURPLE TIP NEEDLES	58
RED TIP NEEDLES	59
TOP STITCH NEEDLES	59

OTHER ACCESSORIES

ACUSTITCH	70
BLUE BOBBIN	67
BOBBIN CASES	67
BOBBINS	67
BRUSH-OUT EMBROIDERY KIT	65
CARRYING BAG	72
CLOTH SETTER for MC15000/MC12000/ MC9900/MC550E/MC500E/MC400E	62
CLOTHSETTER 10000	62
CLOTHSETTER TABLE - for MC11000	62
DRAWER	64
EMBROIDERY COUCHING FOOT SET	65
EMBROIDERY HOOP	75
EMBROIDERY THREAD	66
EXTRA WIDE TABLE	76
INSERT PLATE-A FOR HORIZON SERIES	64
INSERT PLATE-B FOR MC6600P/MC6500P	64
INSERT PLATE-C FOR MC11000/MC11000SE	64
INSERT PLATE-D FOR MC9900	64
INSERT PLATE-E FOR MC15000	64
INSERT PLATE-F FOR SKYLINE & ATELIER SERIES	64
INSERT PLATE-G FOR MC9450/MC9400	64
INSERT PLATE-H FOR MC6700P	64
INSERT PLATE-K FOR CM17 & CM7P	64
INTERLOCKING SEWING MAT	71
KNEE LIFTER	71
LARGE EMBROIDERY DESIGN COLLECTION	65
LARGE FOOT CONTROLLER	68
NET	70
OPTIC MAGNIFIER	74
PIN CUSION	69
PINK BOBBIN	67
PROTECTIVE SHEET	70
REMOTE THREAD CUTTING SWITCH UNIT	68
SEWING MAT	71
SIDE TABLE STAND UNIT	64
SKYLINE ACCESSORY CASE	74
SPOOL HOLDER (SPECIAL)	68
SPOOL STAND	77
STRAIGHT STITCH NEEDLE PLATE	73
UNIVERSAL TABLE STAND FOR CONTINENTAL SERIES	63
UNIVERSAL TABLE STAND FOR HIGH SPEED STRAIGHT STITCH MODELS	63
UNIVERSAL TABLE STAND WITH DRAWER	63
UNIVERSAL TABLE STAND WITHOUT DRAWER	63

JANOME

JANOME Corporation

ACCESSORY
ACCTALOG